

KROFTMAN CT-S-HS-1200

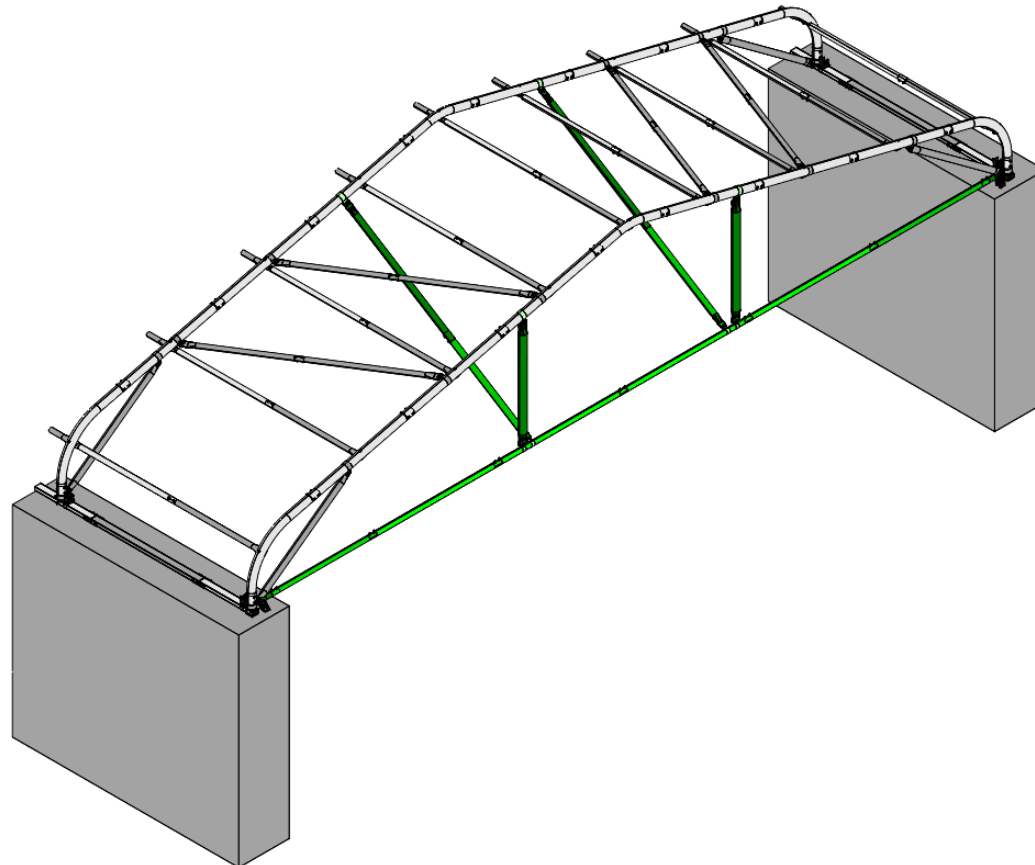

Assembly manual for suspended half end wall frame

Montageanleitung für abgehängte Halbstirnwandzarge

Manuel d'assemblage pour le cadre mural suspendu en demi-lune

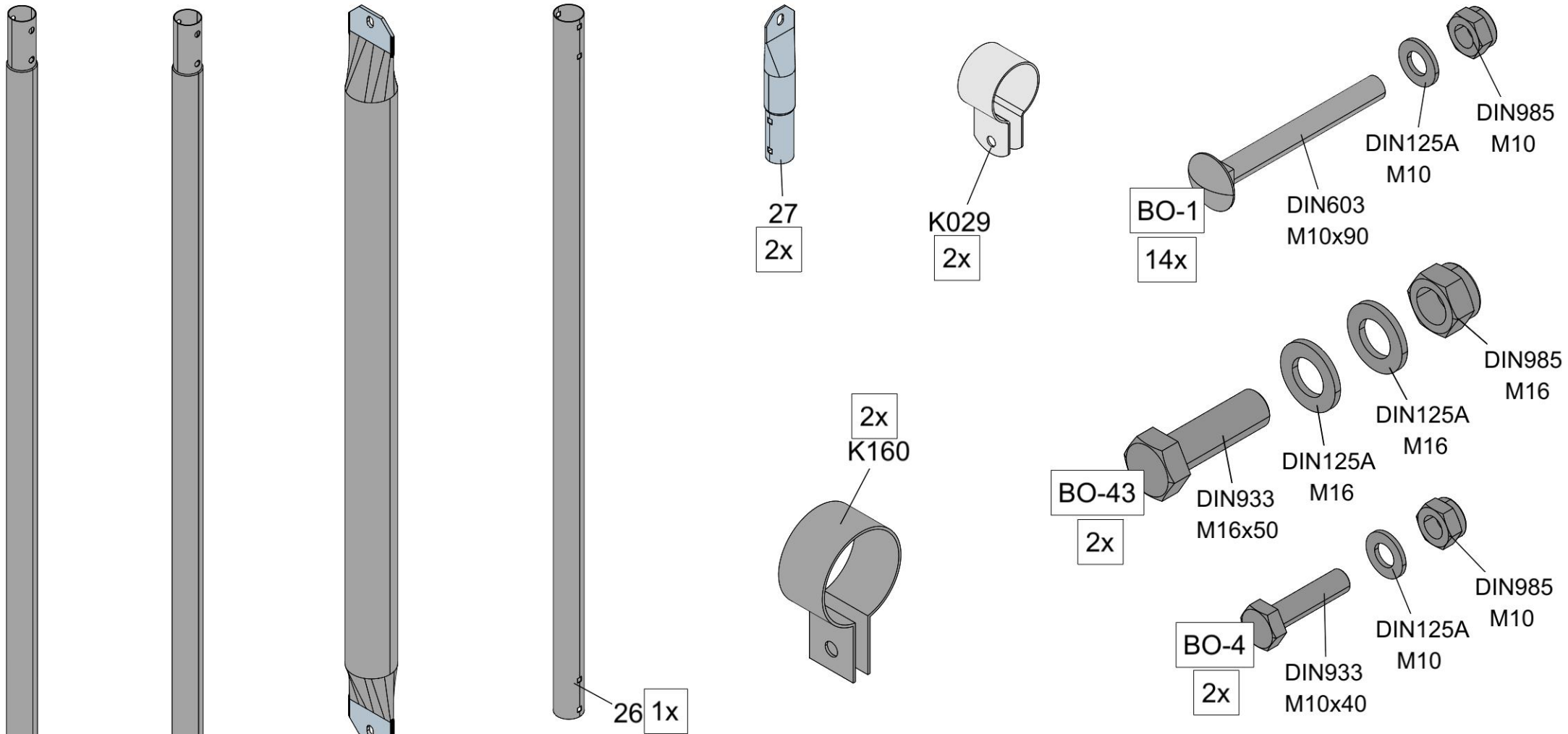



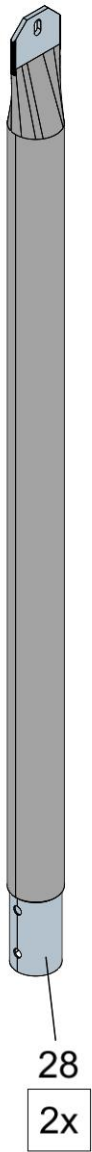
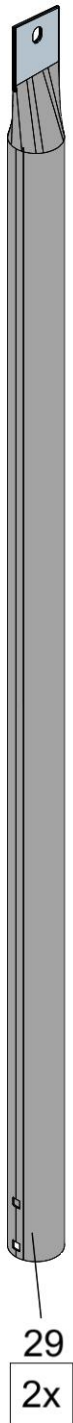

 Needed for cover assembly
 Erforderlich für die Montage der Abdeckung
 Nécessaire pour l'assemblage du couvercle

36 1x
 37 2x
 K012 3x
 6x K014



 Parts list for extra braces
 Stückliste für zusätzliche Streben
 Liste des pièces pour les renforts supplémentaires

