

KROFTMAN CT-S-806 / CT-S-812

Assembly manual for main cover

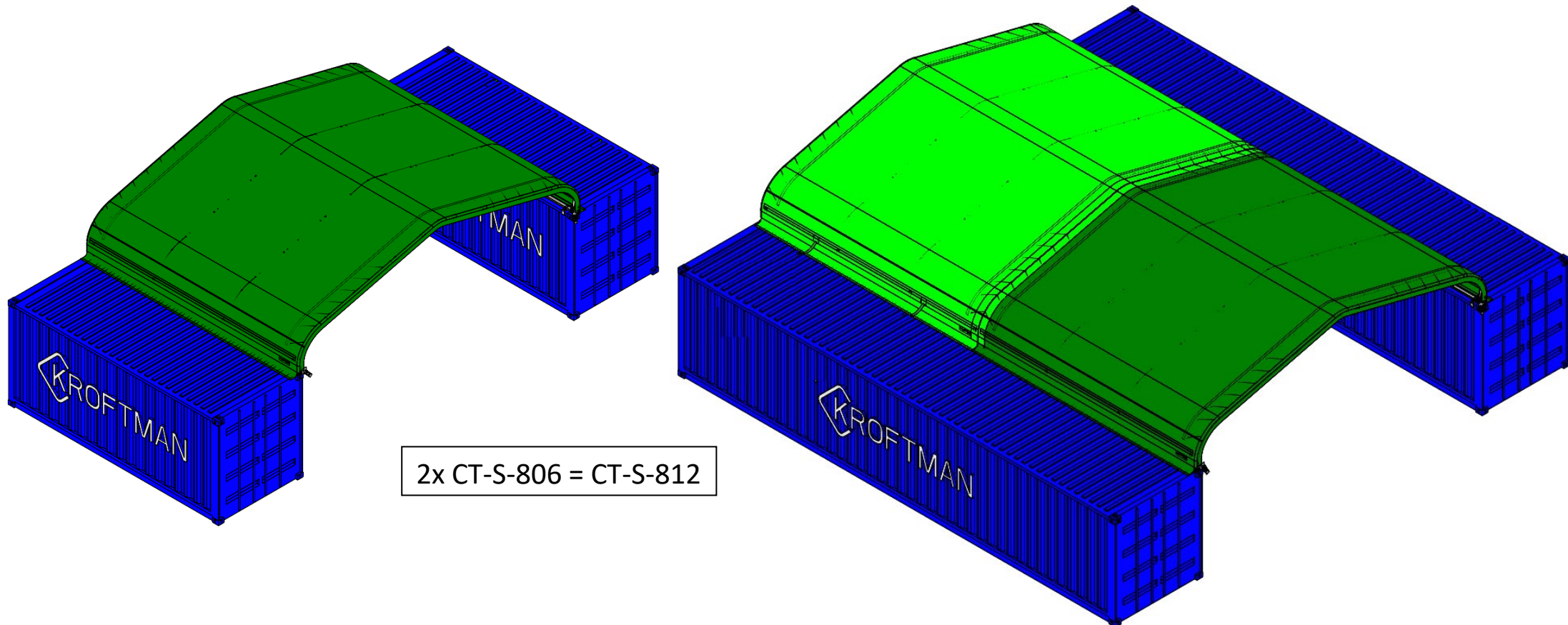

Montageanleitung für die Dachplane



Manuel d'assemblage du couvercle principal

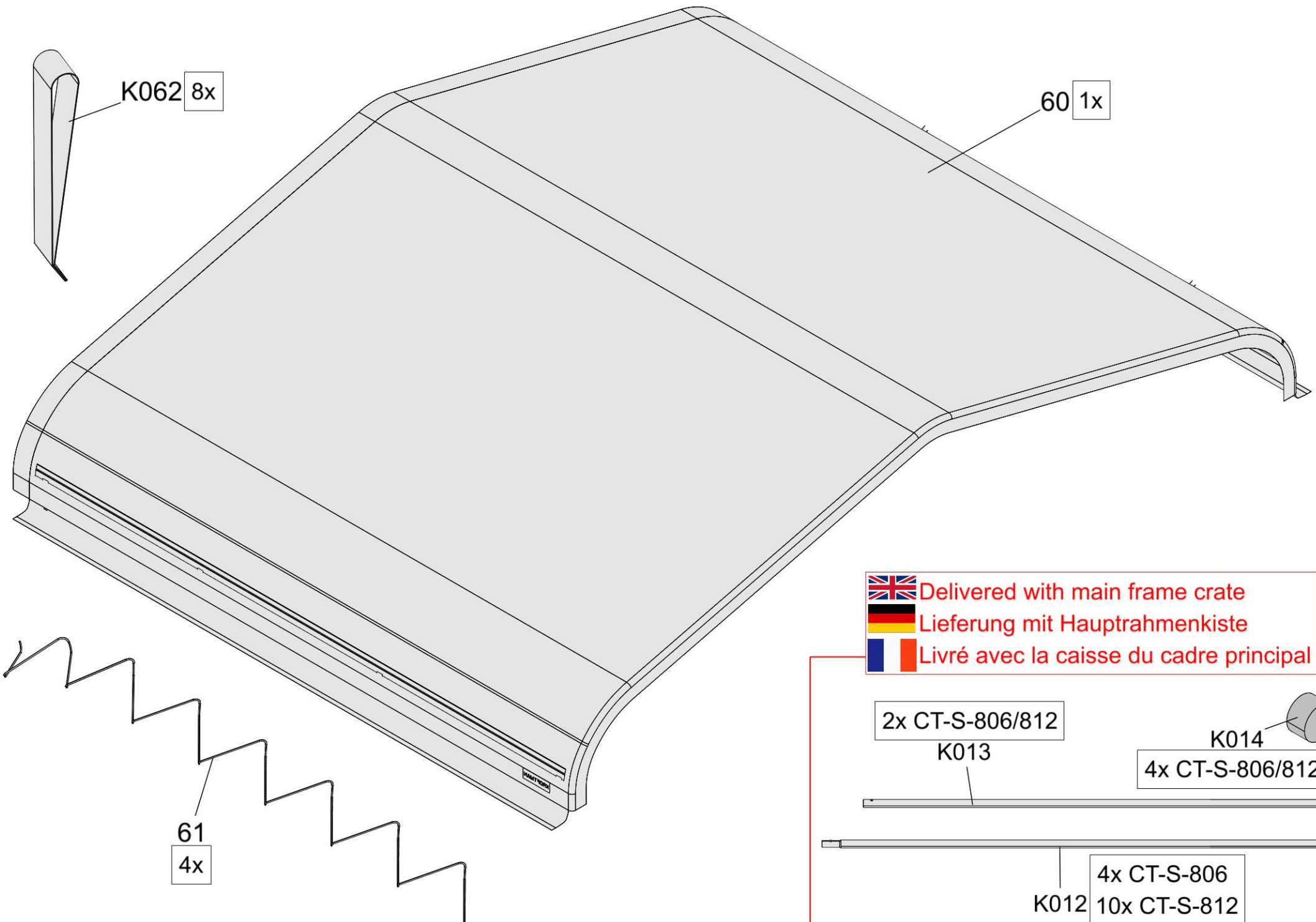

2x CT-S-806 = CT-S-812





 Delivered with main frame crate
 Lieferung mit Hauptrahmenkiste
 Livré avec la caisse du cadre principal

-  First cover
-  Erste Plane
-  Première couverture

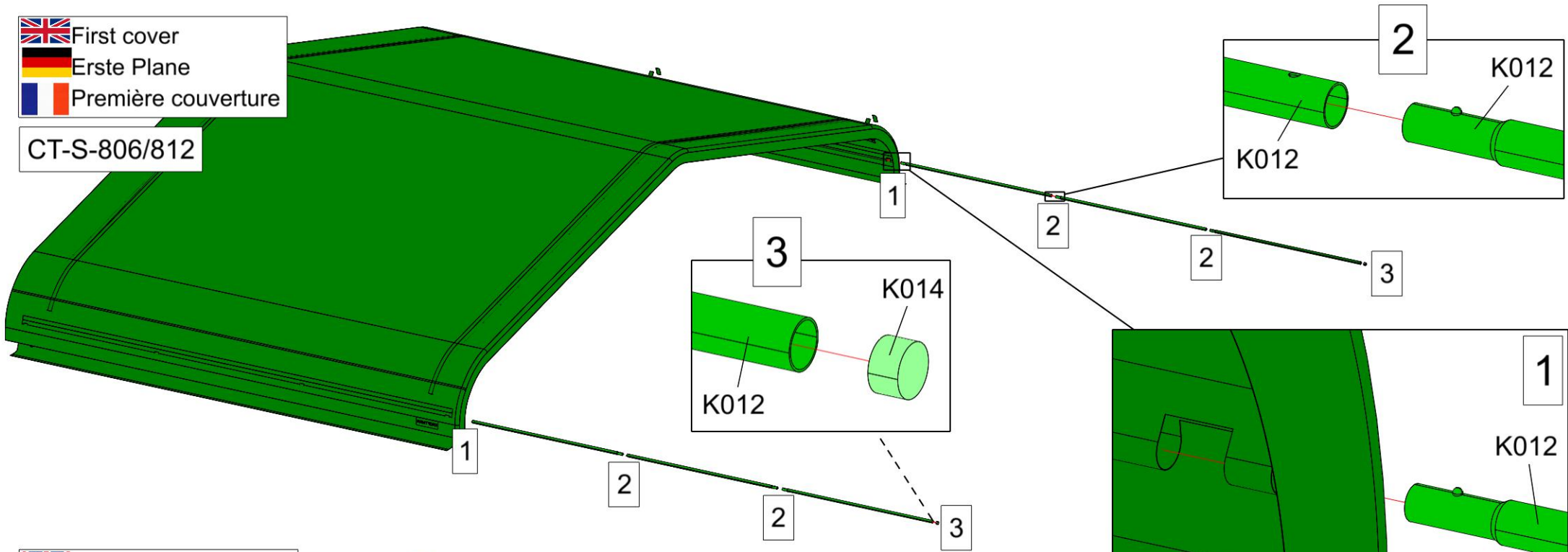

CT-S-806/812



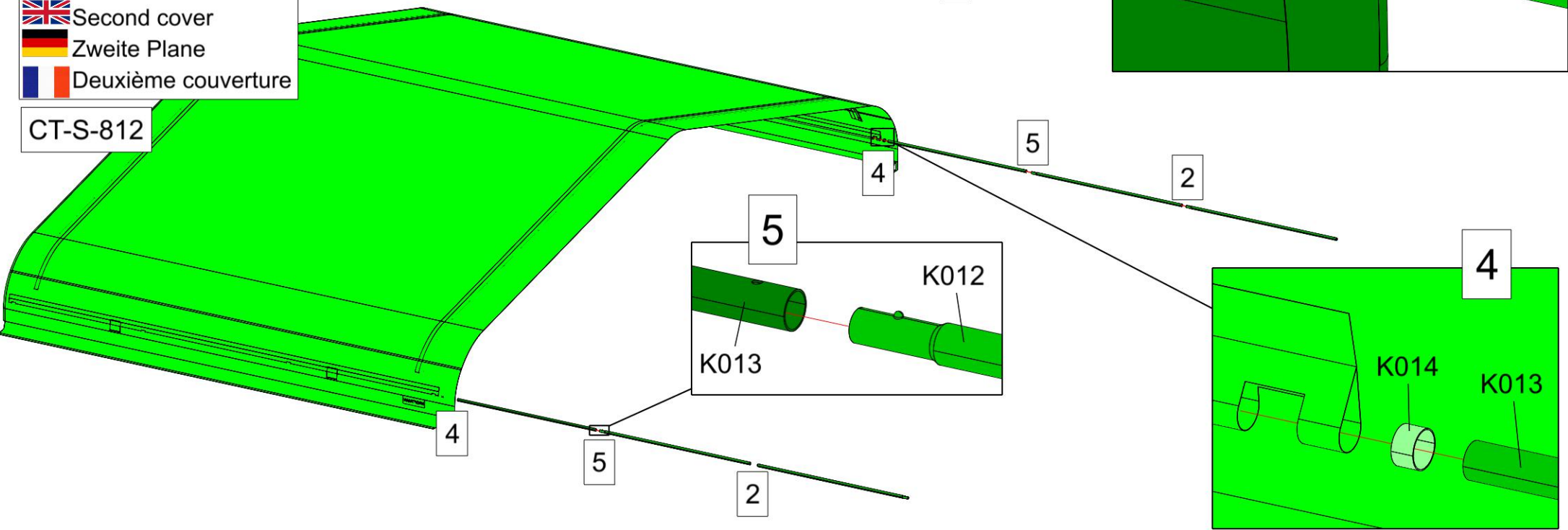

-  Second cover
-  Zweite Plane
-  Deuxième couverture

CT-S-812







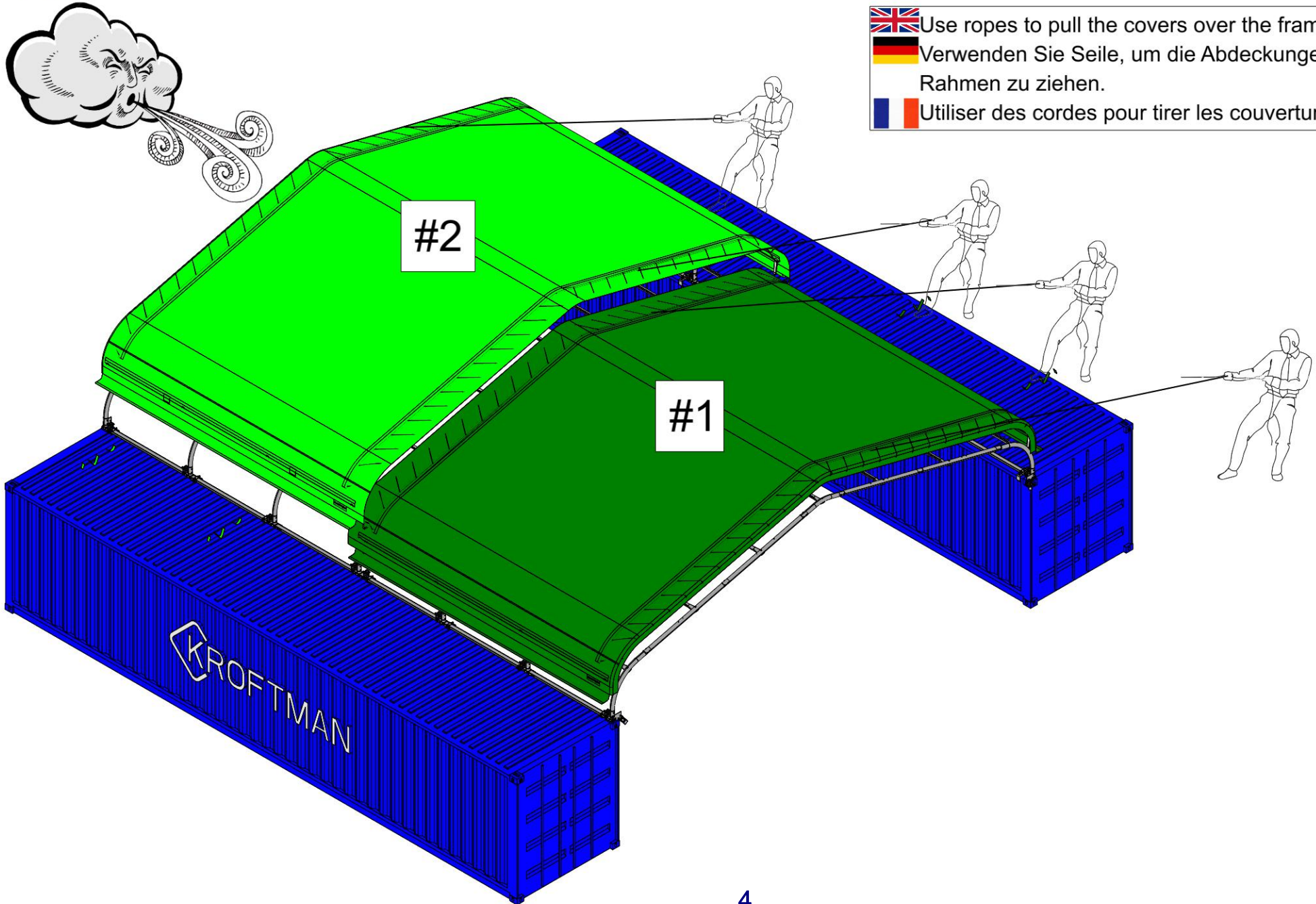

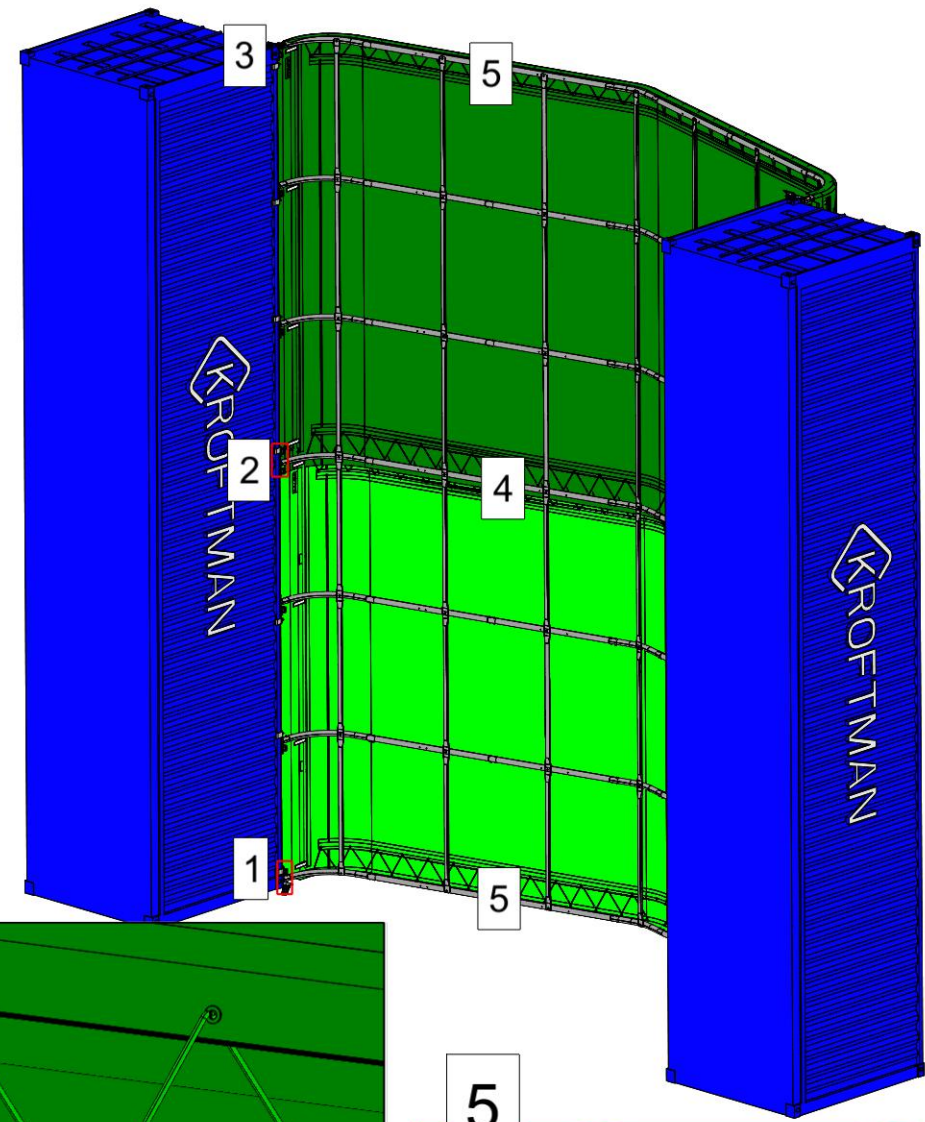
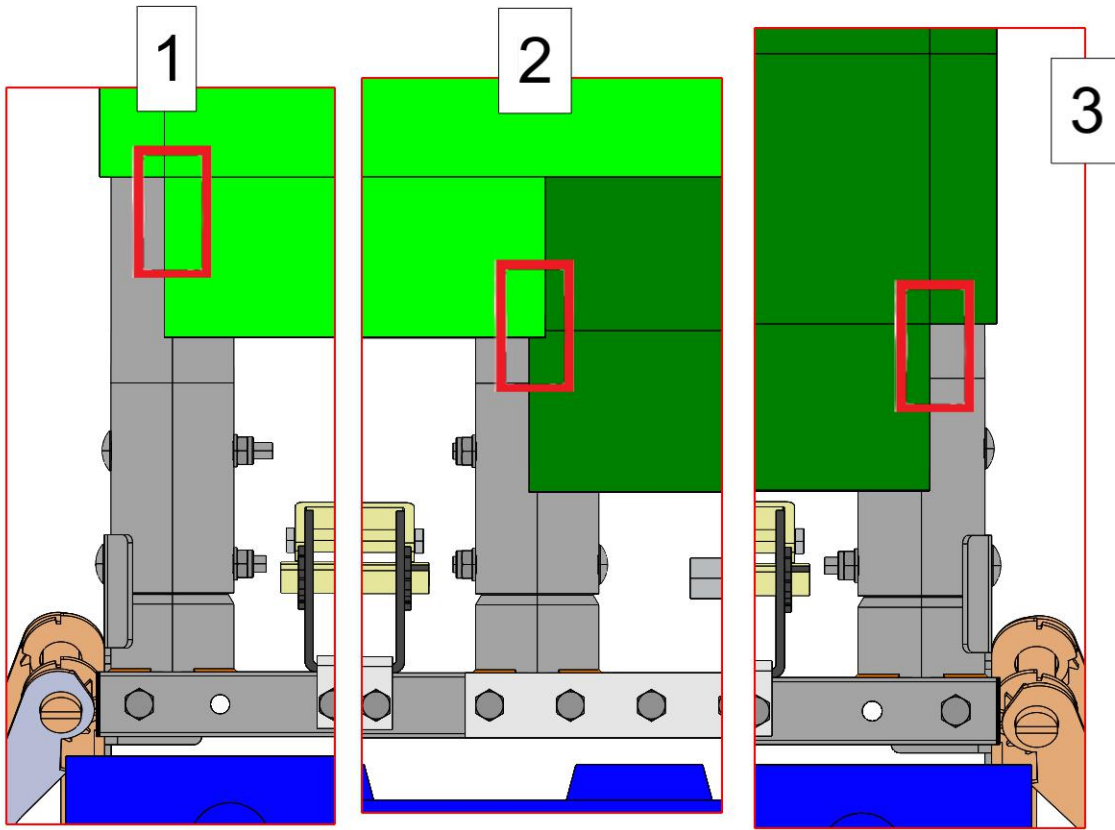
 Keep the wind direction in mind, so that water is not blown between the covers
 Beachten Sie die Windrichtung, damit kein Wasser zwischen die Planen geblasen wird.
 Gardez à l'esprit la direction du vent, afin que l'eau ne soit pas projetée entre les couvertures.

 Use ropes to pull the covers over the frame
 Verwenden Sie Seile, um die Abdeckungen über den Rahmen zu ziehen.
 Utiliser des cordes pour tirer les couvertures sur le cadre.









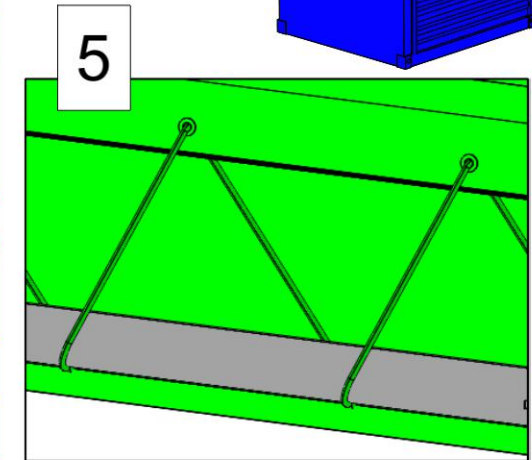
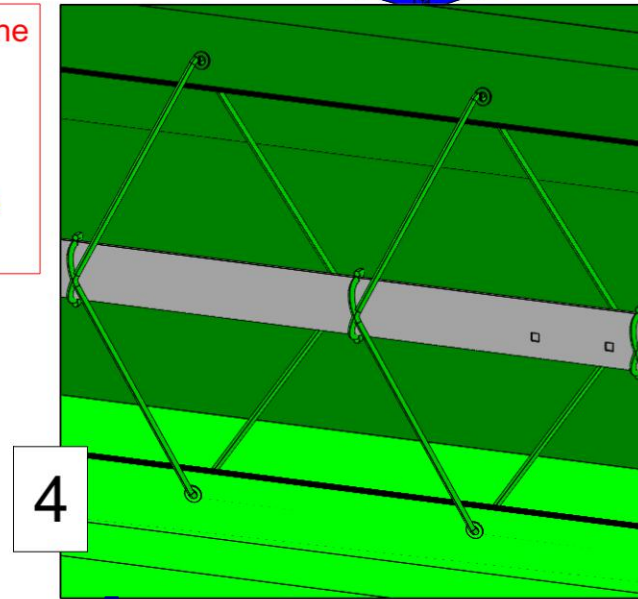

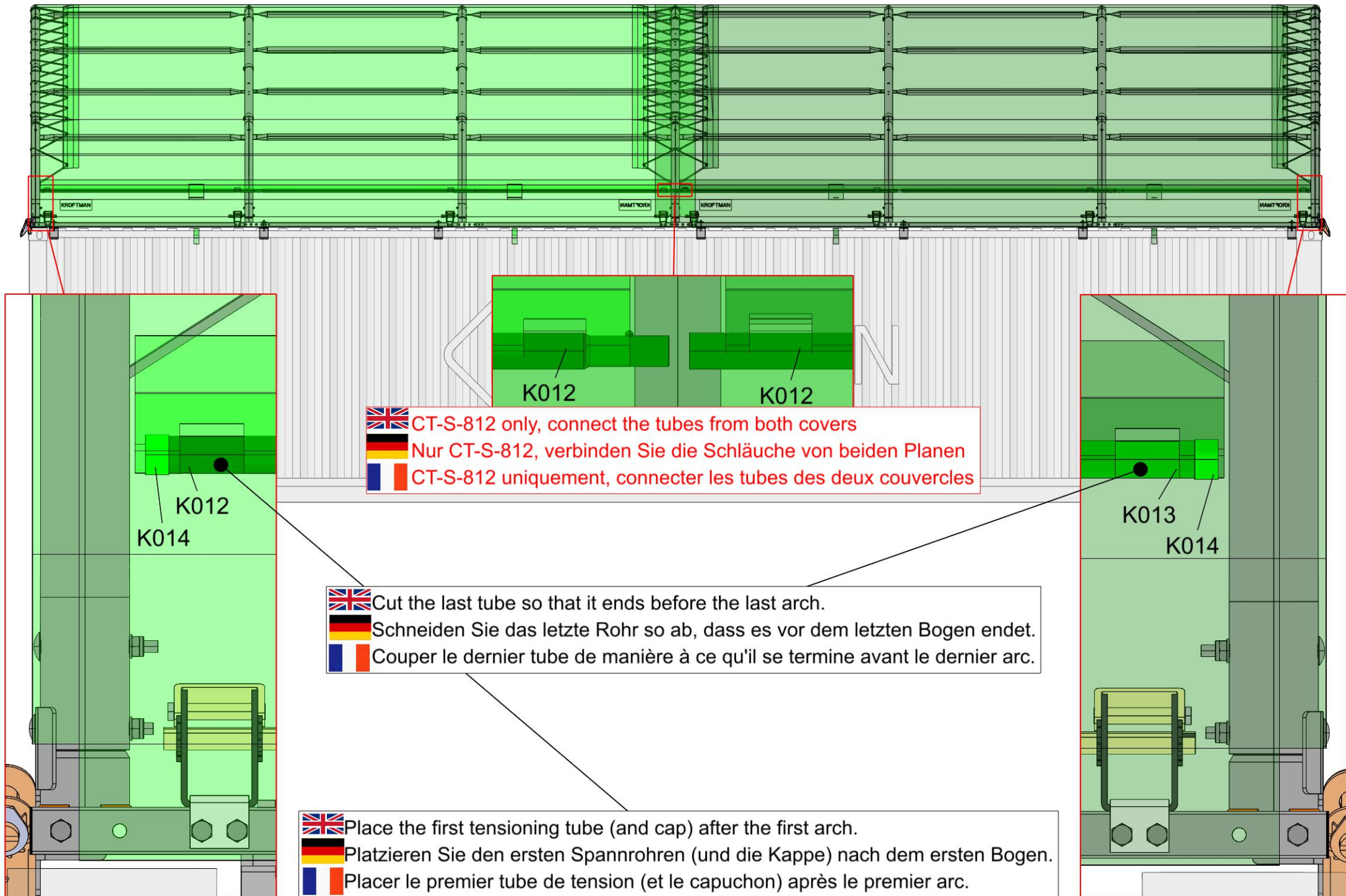
-  Make sure that the roof cover(s) are centered on the middle of the second / second to last arch of the roof frame.
-  Achten Sie darauf, dass die Plane(n) in der Mitte des zweiten / vorletzten Bogens des Dachrahmens zentriert sind.
-  Veillez à ce que le(s) couvercle(s) de toit soit(nt) centré(s) sur le milieu du deuxième / avant-dernier arc de la charpente.

-  Place the ends of the cover(s) in the middle of the arch tubes
-  Legen Sie die Enden der Plane(n) in die Mitte der Bogenrohre
-  Placer les extrémités du (des) couvercle(s) au milieu des tubes de l'arceau.









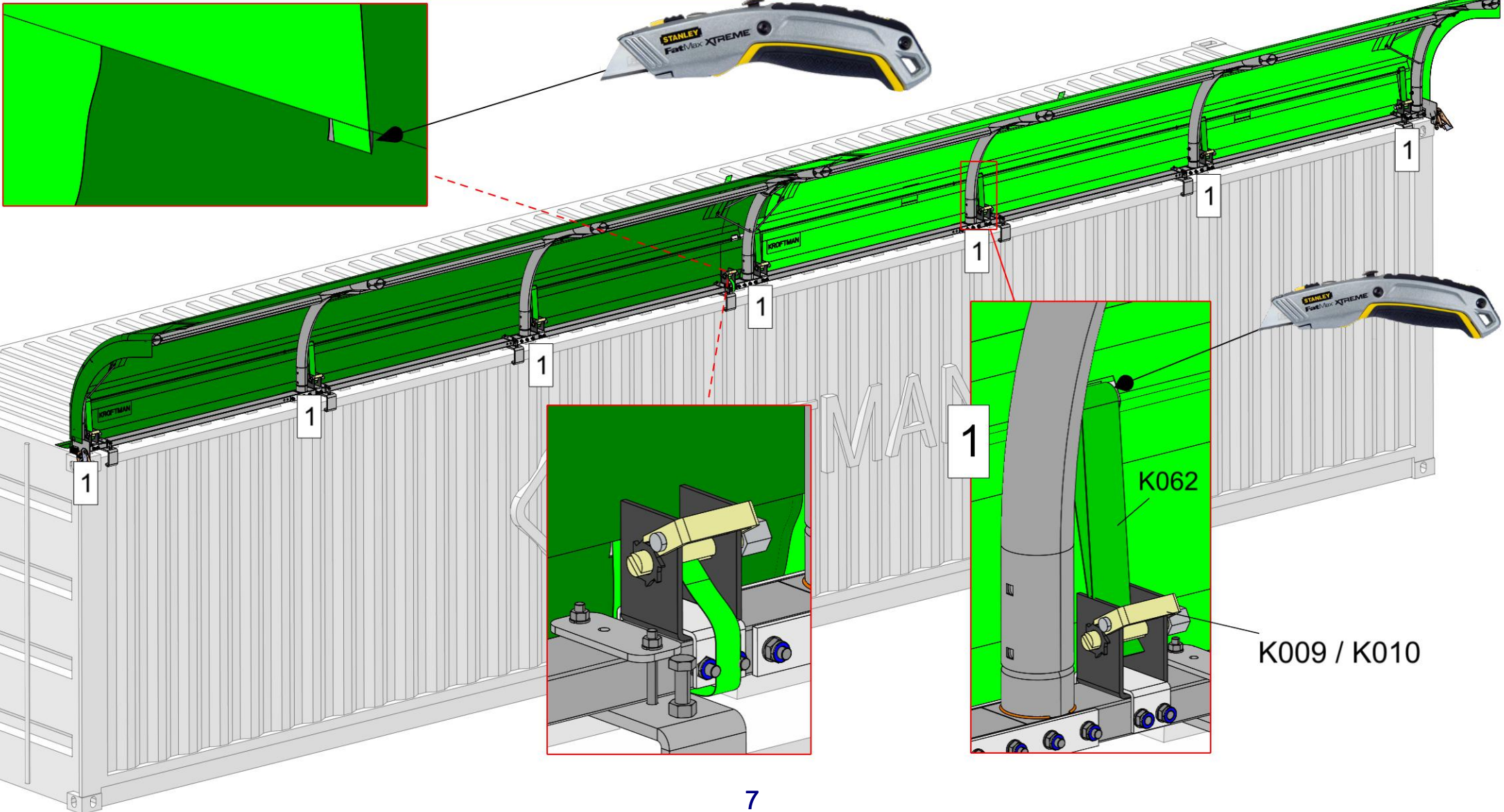

-  CT-S-812 only, cut a hole in the first cover, insert the strap of the second cover through it, attach the strap to the ratchet and tighten the strap
-  Nur CT-S-812, schneiden Sie ein Loch in die erste Plane, führen Sie den Gurt der zweiten Plane hindurch, befestigen Sie den Gurt an der Ratsche und ziehen Sie den Gurt fest.
-  CT-S-812 uniquement, découpez un trou dans la première couverture, insérez la sangle de la deuxième couverture à travers cetrou, attachez la sangle au cliquet et serrez la sangle.

-  Use the "K062" straps and the "K009", "K010" ratchets to stretch the roof cover
-  Verwenden Sie die Gurte "K062" und die Ratschen "K009" und "K010", um die Dachabdeckung zu spannen.
-  Utiliser les sangles "K062" et les cliquets "K009", "K010" pour tendre la couverture du toit.

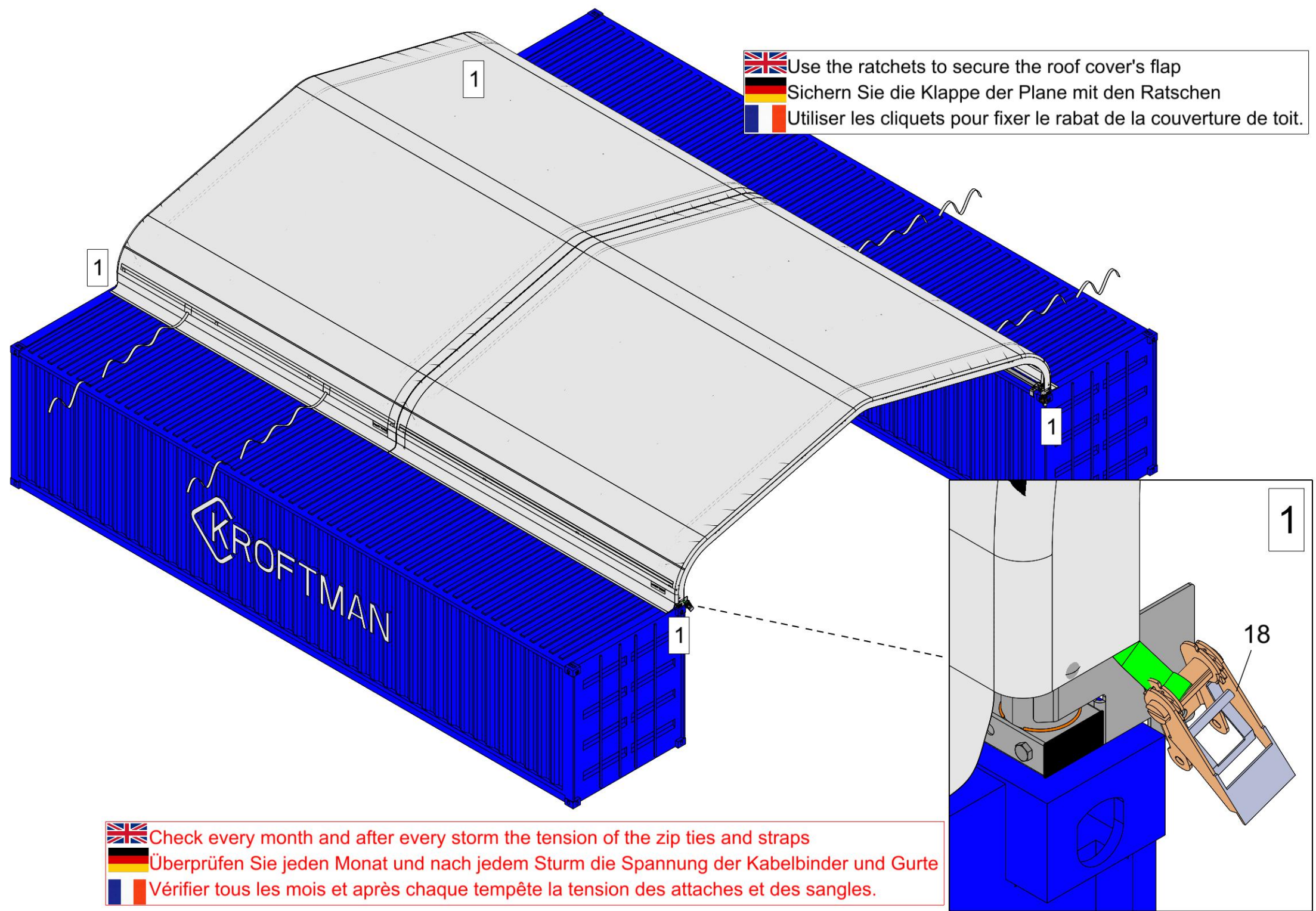

 Use the ratchets to secure the roof cover's flap
 Sichern Sie die Klappe der Plane mit den Ratschen
 Utiliser les cliquets pour fixer le rabat de la couverture de toit.



 Check every month and after every storm the tension of the zip ties and straps
 Überprüfen Sie jeden Monat und nach jedem Sturm die Spannung der Kabelbinder und Gurte
 Vérifier tous les mois et après chaque tempête la tension des attaches et des sangles.