

CONTAINER CAN ALSO BE PLACED ON THE LEFT SIDE

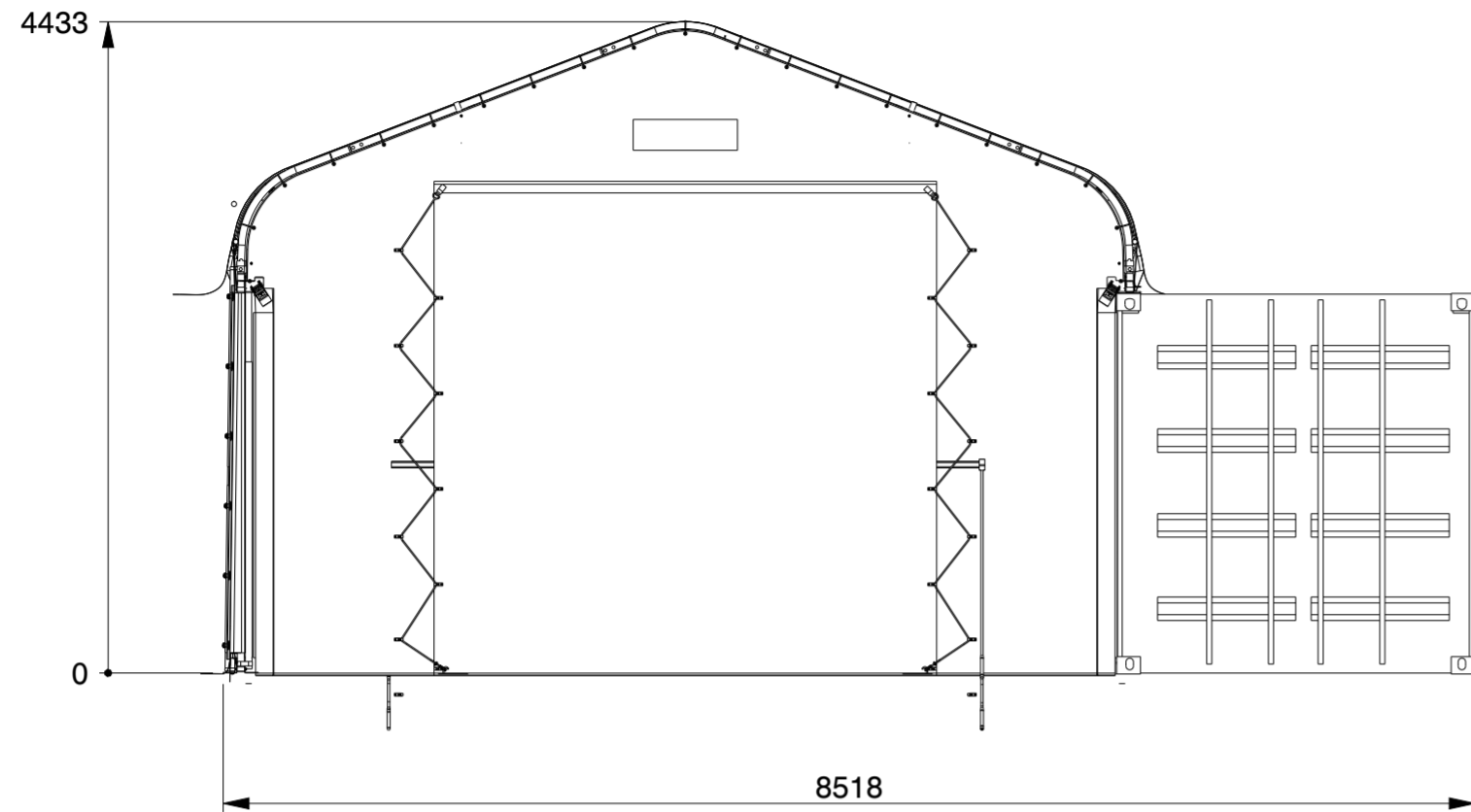

ISO containers  
Optional end walls

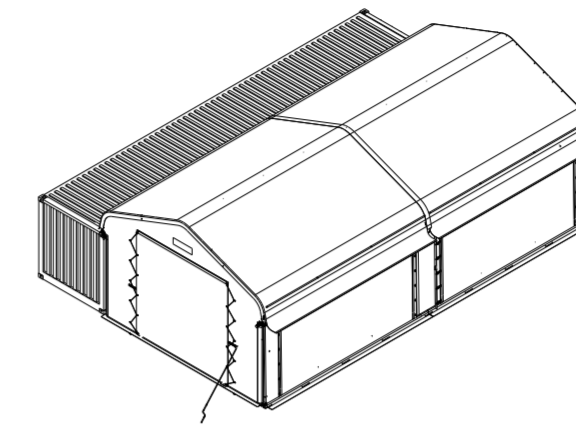

SCALE 1:200

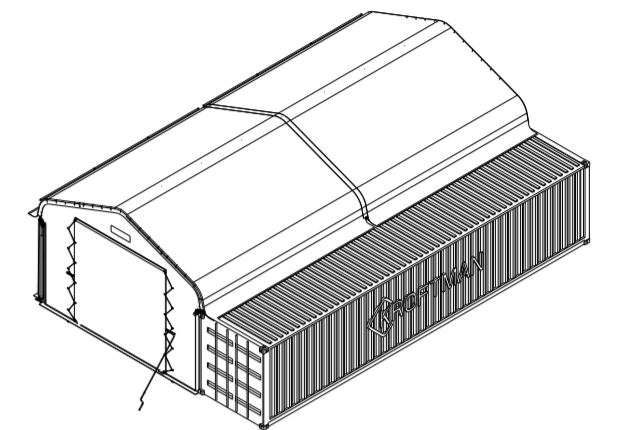

SCALE 1:200

CONTAINER CAN ALSO BE PLACED ON THE LEFT SIDE

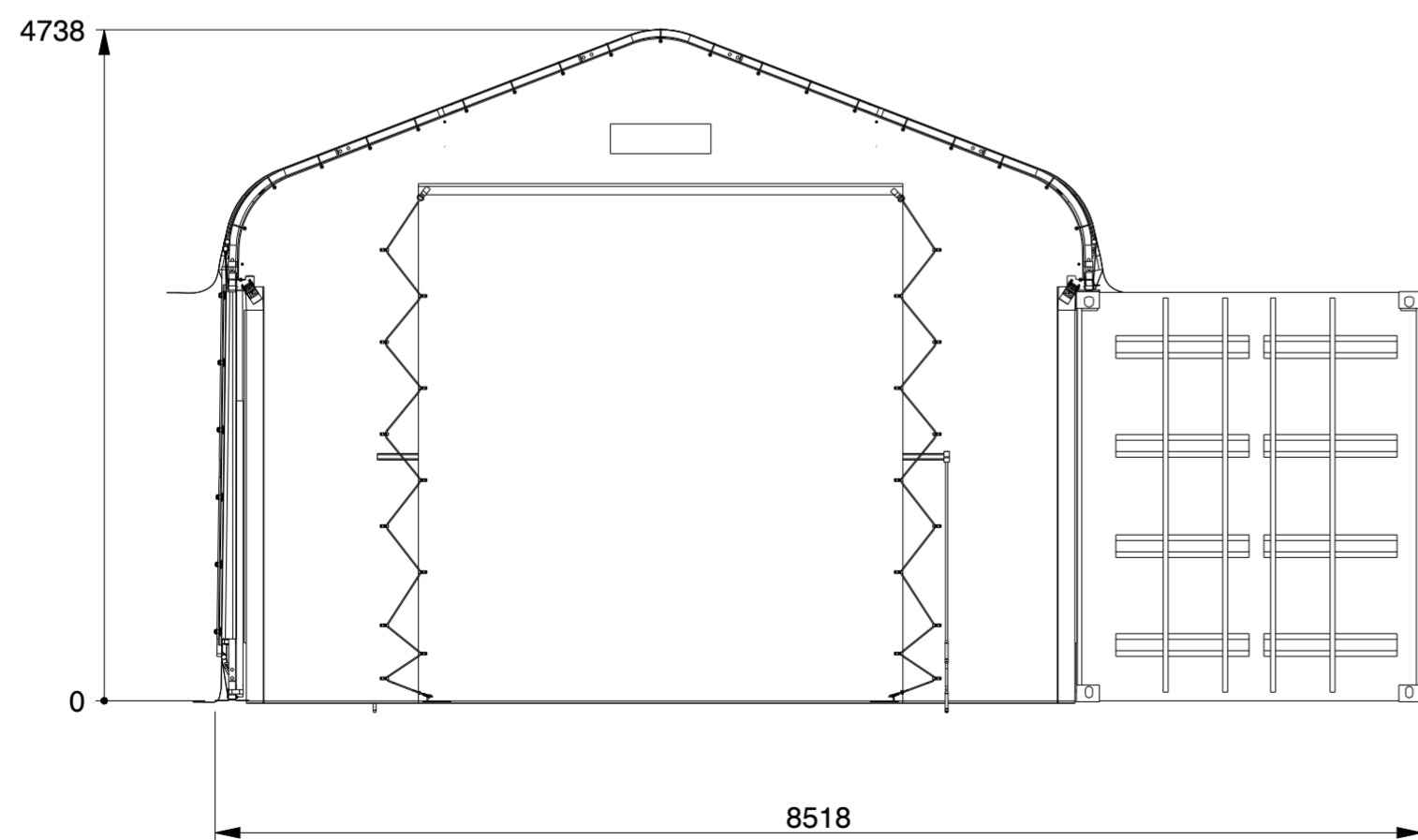

High-Cube containers  
Optional end walls

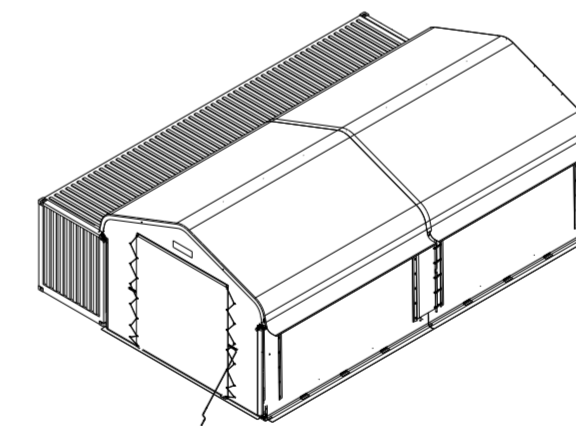

SCALE 1:200

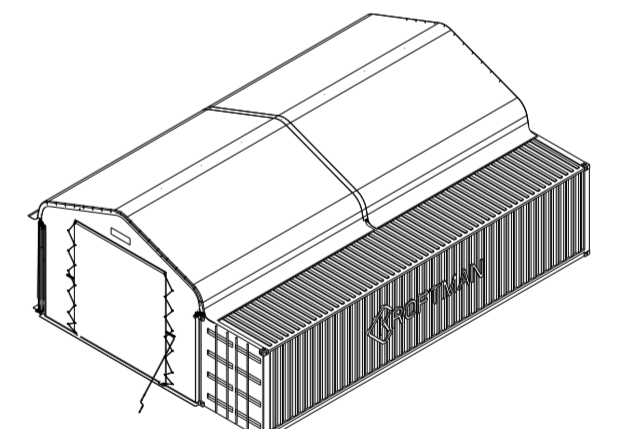

SCALE 1:200

<b>KROFTMAN</b>	LASERCUT ACCORDING: EN-ISO 9013-5-4-1		MATERIAL: See List	
	MATERIAL CERTIFICATE: 3.1 (OR 2.2 WHEN S235JR)		TREATMENT: None	
	GALVANIZING ACCORDING: EN ISO 1461		STATUS: Released	
	BEND RADIUS UNLESS DEFINED R <sub>i</sub> =1		TOLERANCES UNLESS OTHERWISE SPECIFIED:	
GENERAL ROUGHNESS Ra x	DIMENSION: ±x	ANGLE: ±x°	MODEL NUMBER TCA0154	REVISION: 0
DESCRIPTION: CT-S-SW-612 Container top with side wall ISO and HC				
SCALE: 1:50	UNITS: mm	PROJECTION: 	MODIFIED ON: 26-09-2024	APPROVED ON: 26-09-2024
		MASS: 4012,6 kg	MODIFIED BY: AVA	APPROVED BY: BVB
			Sheet 1 of 5	Size: A2
© KROFTMAN STRUCTURES B.V. Duplication and copying without written permission of the owner is prohibited				

DRAWING NAME: TCA0154

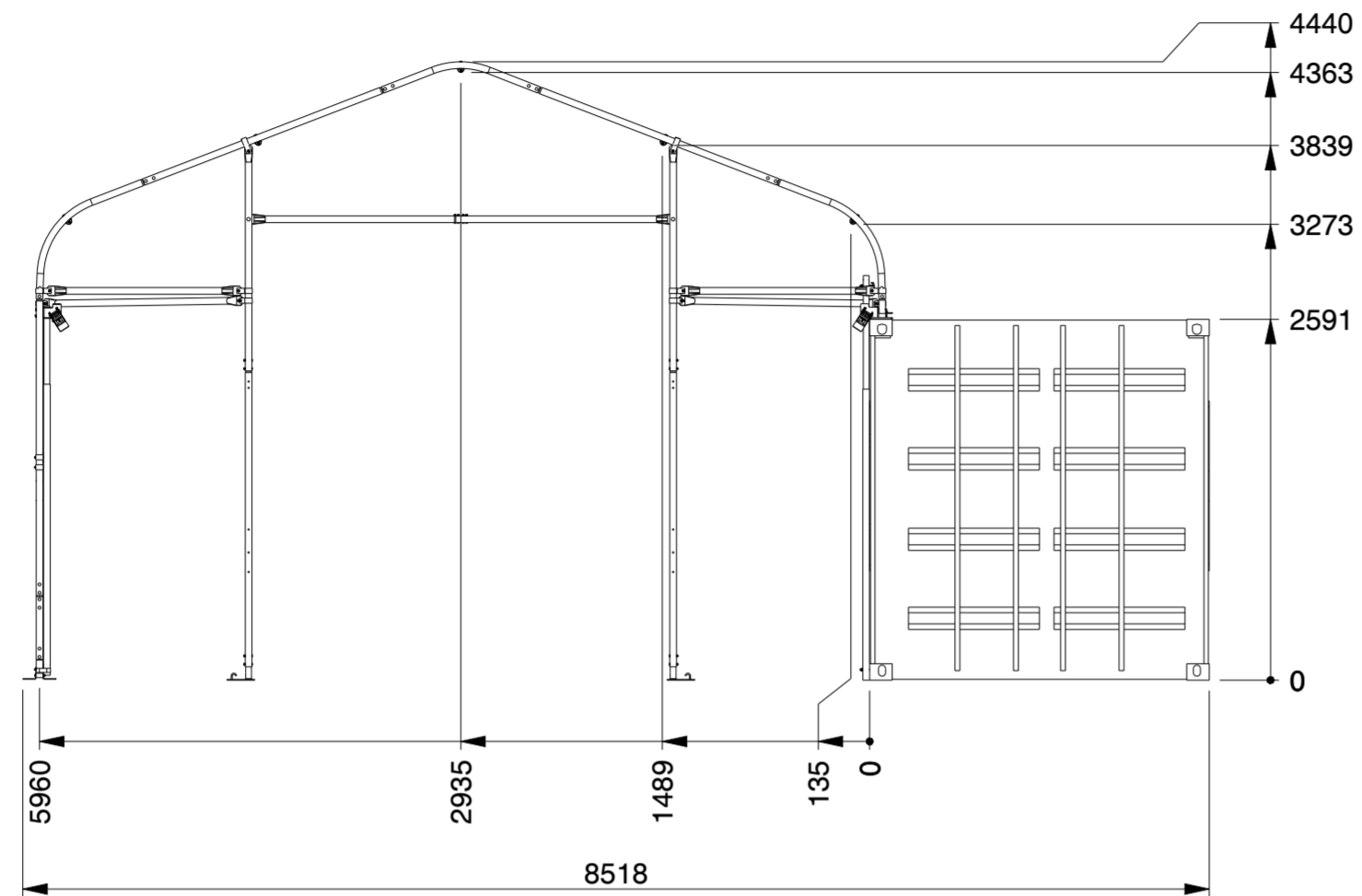

ISO containers  
Optional end walls

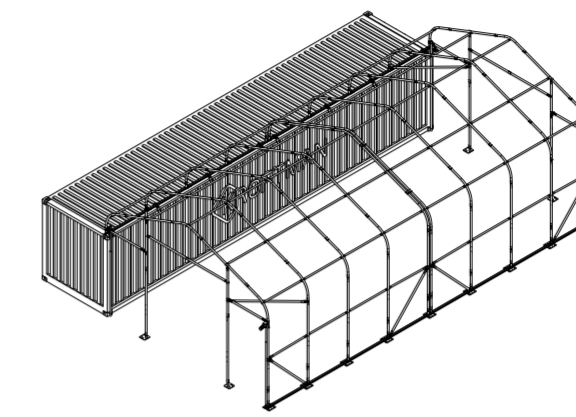

SCALE 1:200

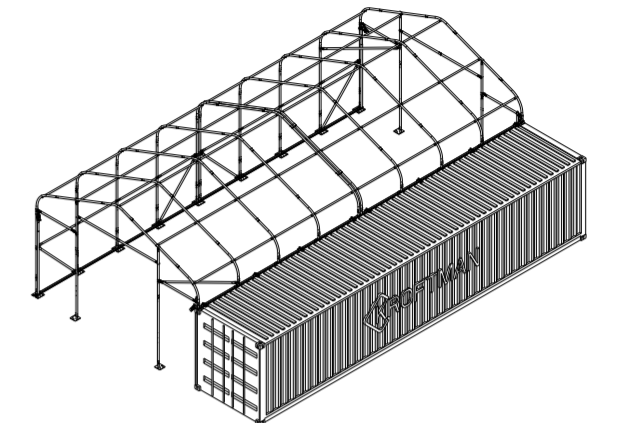

SCALE 1:200

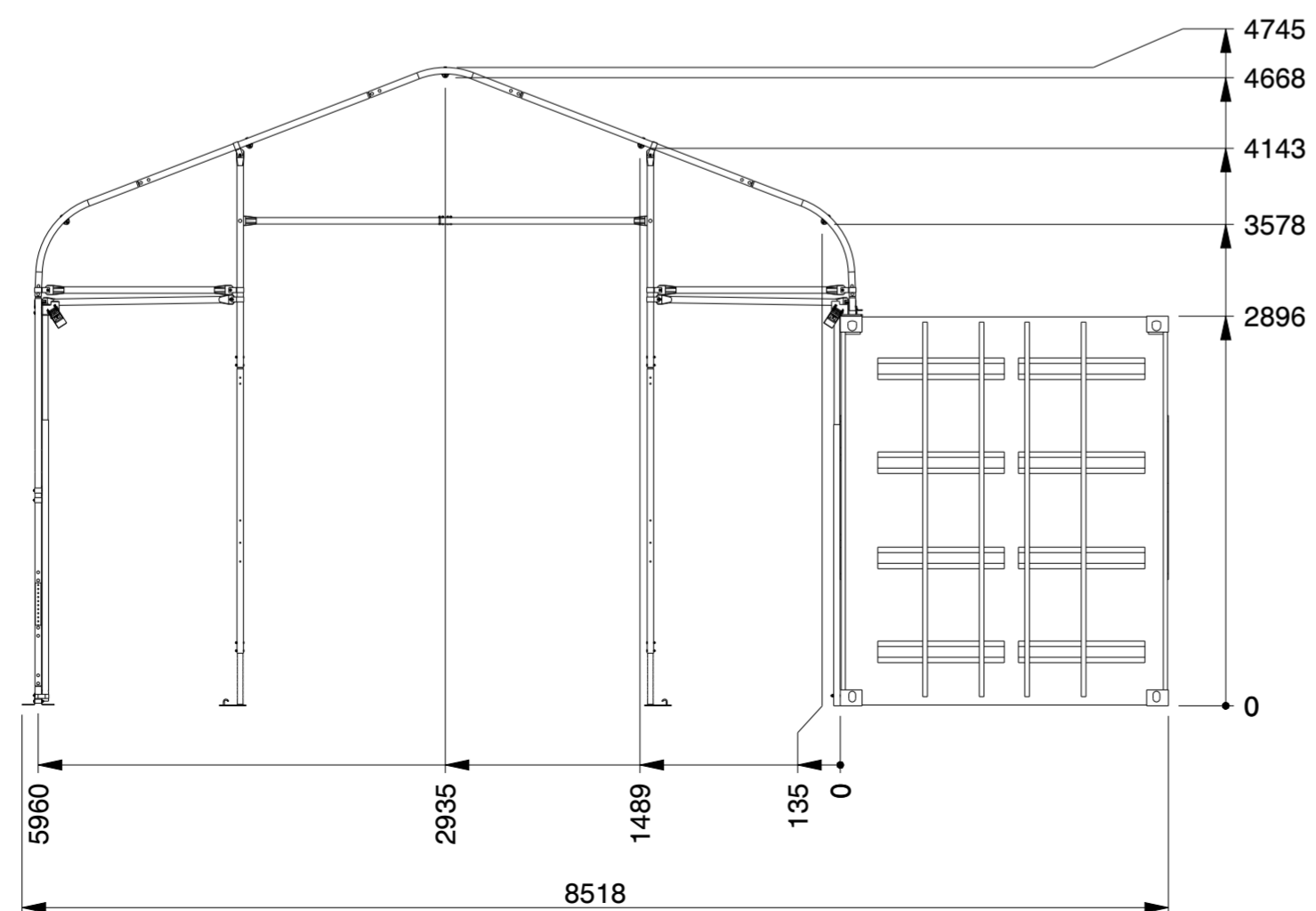

High-Cube containers  
Optional end walls

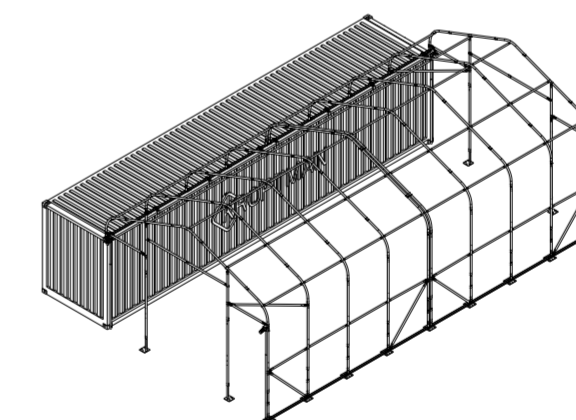

SCALE 1:200

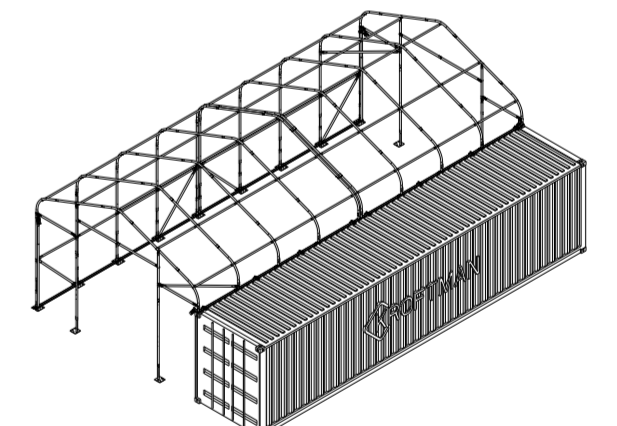

SCALE 1:200

<b>KROFTMAN</b>	LASERCUT ACCORDING: EN-ISO 9013-5-4-1		MATERIAL: See List	
	MATERIAL CERTIFICATE: 3.1 (OR 2.2 WHEN S235JR)		TREATMENT: None	
	GALVANIZING ACCORDING: EN ISO 1461		STATUS: Released	
	BEND RADIUS UNLESS DEFINED R <sub>i</sub> =t			
TOLERANCES UNLESS OTHERWISE SPECIFIED:				
GENERAL ROUGHNESS Ra x	DIMENSION: ±x	ANGLE: ±x°	MODEL NUMBER <b>TCA0154</b>	REVISION: <b>0</b>
DESCRIPTION: <b>CT-S-SW-612 Container top with side wall ISO and HC</b>				
SCALE: 1:50	UNITS: mm	PROJECTION: 	MODIFIED ON: 26-09-2024	APPROVED ON: 26-09-2024
			MODIFIED BY: AVA	APPROVED BY: BVB
			MASS: 4012,6 kg	Sheet 2 of 5
				Size: A2
© KROFTMAN STRUCTURES B.V. Duplication and copying without written permission of the owner is prohibited				

DRAWING NAME: TCA0154

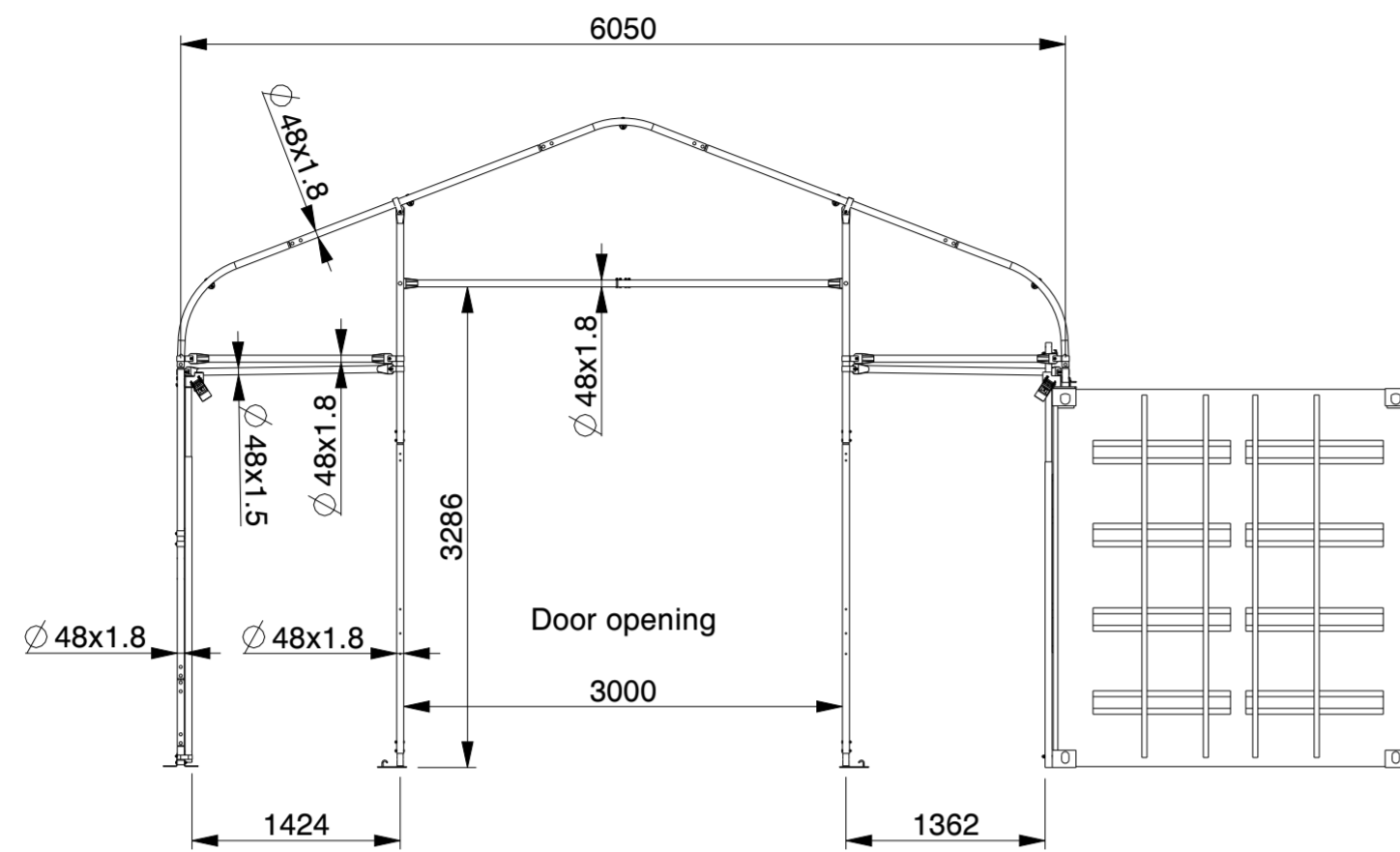

ISO containers  
Optional end walls

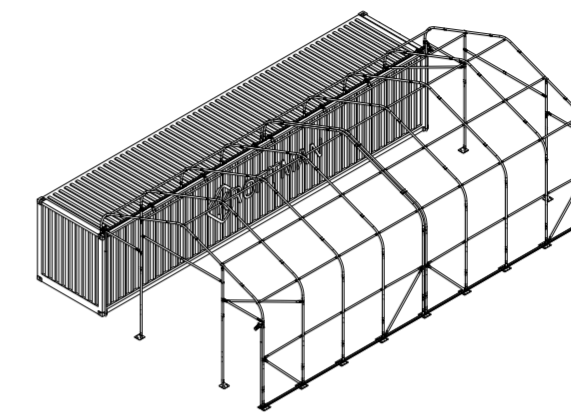

SCALE 1:200

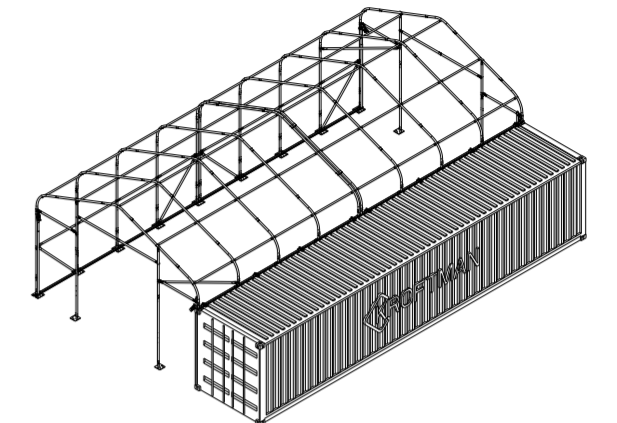

SCALE 1:200

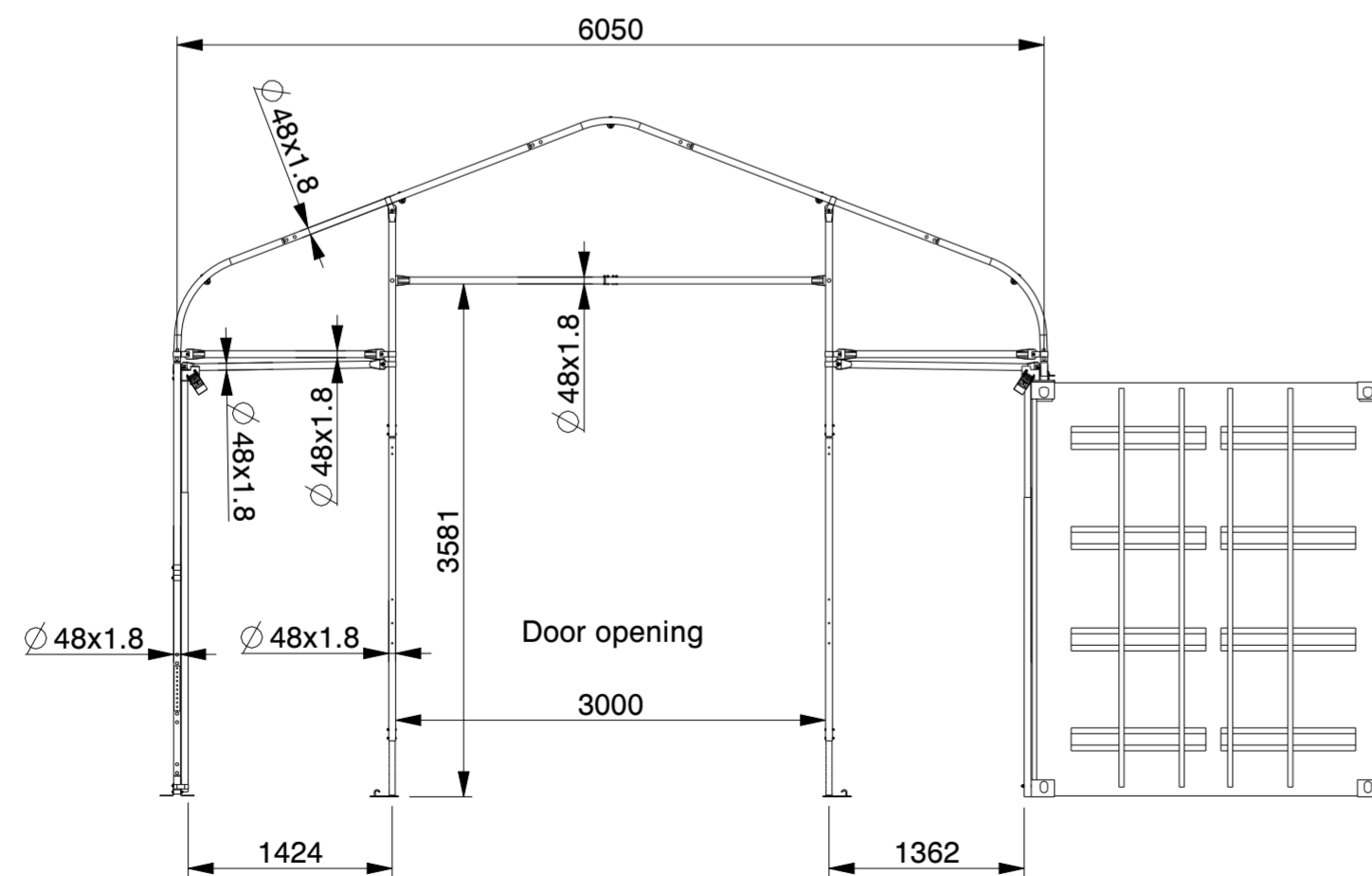

High-Cube containers  
Optional end walls

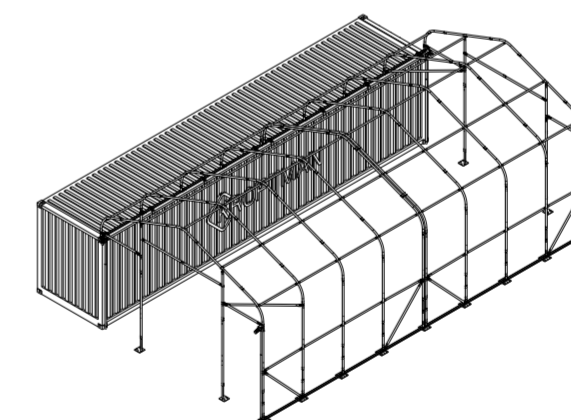

SCALE 1:200

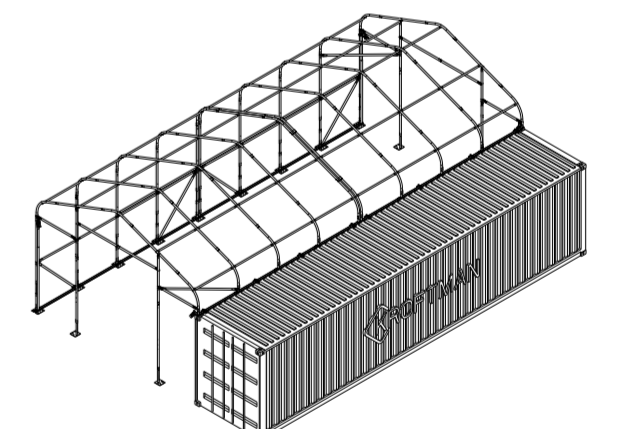

SCALE 1:200

<b>KROFTMAN</b>	LASERCUT ACCORDING: EN-ISO 9013-5-4-1		MATERIAL: See List	
	MATERIAL CERTIFICATE: 3.1 (OR 2.2 WHEN S235JR)		TREATMENT: None	
	GALVANIZING ACCORDING: EN ISO 1461		STATUS: Released	
	BEND RADIUS UNLESS DEFINED R <sub>i</sub> =1			
TOLERANCES UNLESS OTHERWISE SPECIFIED:				
GENERAL ROUGHNESS Ra x	DIMENSION: ±x	ANGLE: ±x°	MODEL NUMBER TCA0154	REVISION: 0
DESCRIPTION: <b>CT-S-SW-612 Container top with side wall ISO and HC</b>				
SCALE: 1:50	UNITS: mm	PROJECTION: 	MODIFIED ON: 26-09-2024	APPROVED ON: 26-09-2024
			MODIFIED BY: AVA	APPROVED BY: BVB
			MASS: 4012,6 kg	Sheet 3 of 5 Size: A2
© KROFTMAN STRUCTURES B.V. Duplication and copying without written permission of the owner is prohibited				

DRAWING NAME: TCA0154

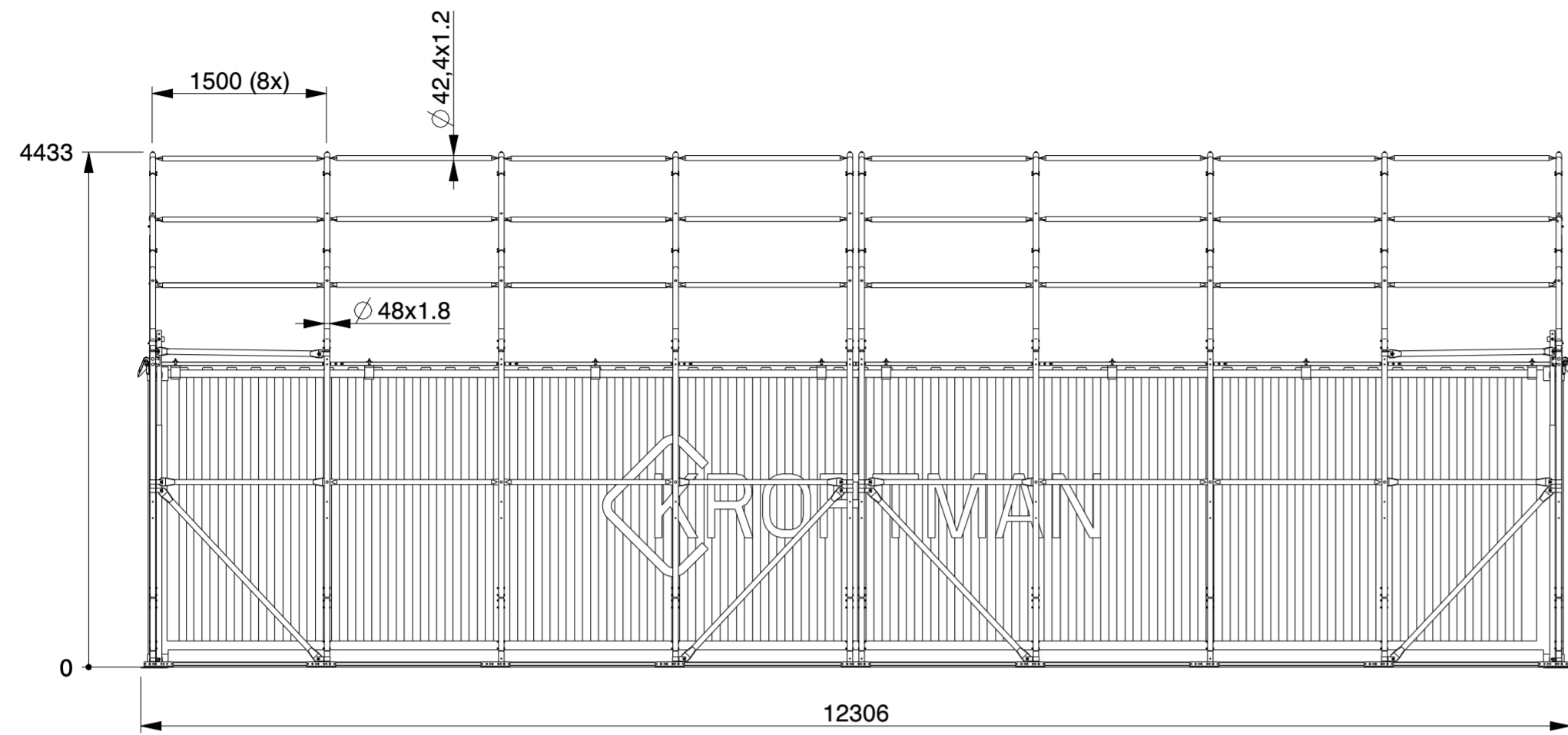

ISO containers  
Optional end walls

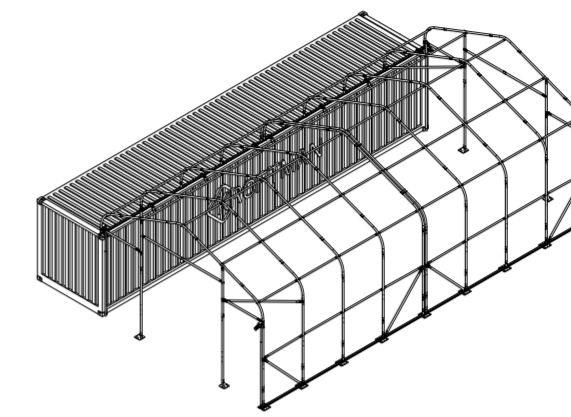

SCALE 1:200

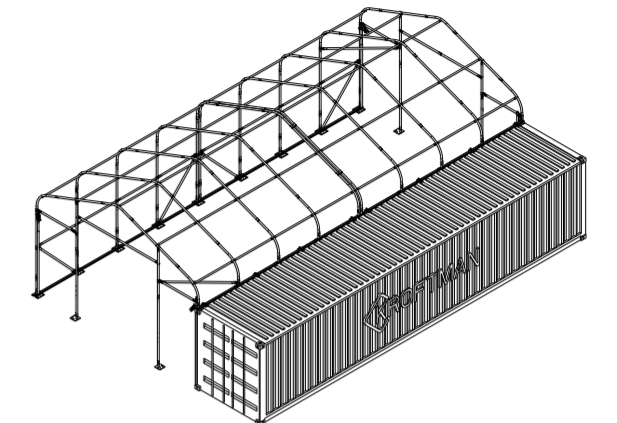

SCALE 1:200

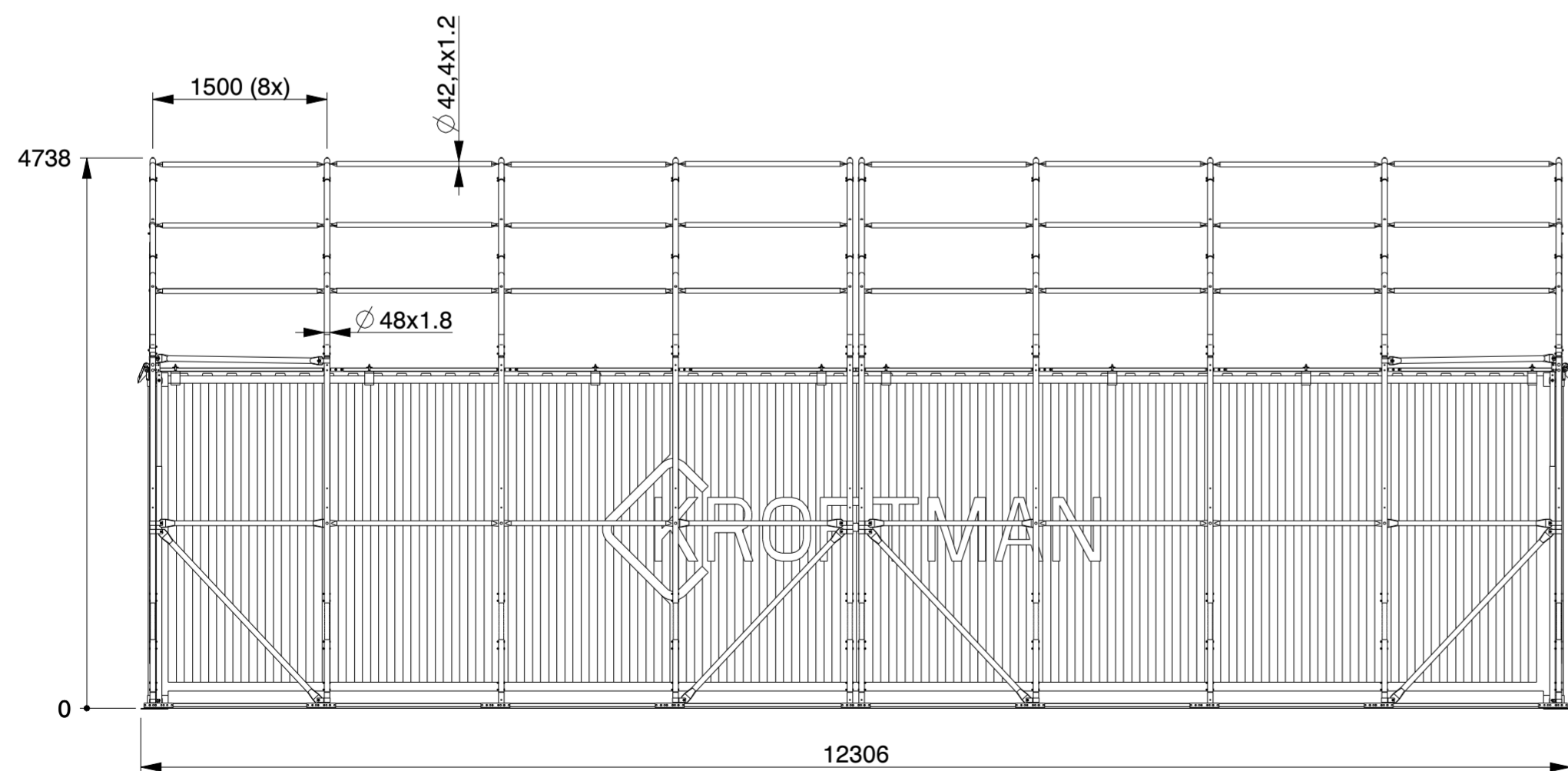

High-Cube containers  
Optional end walls

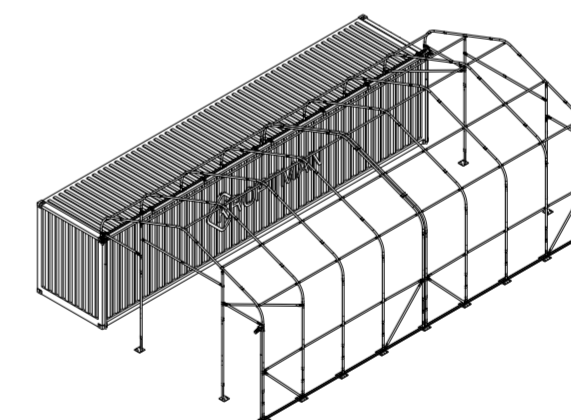

SCALE 1:200

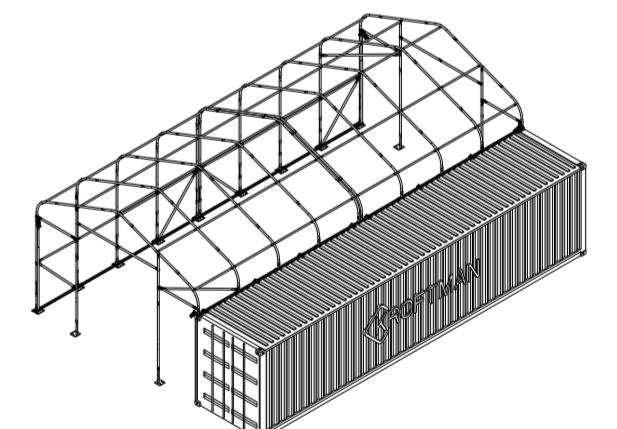

SCALE 1:200

<b>KROFTMAN</b>	LASERCUT ACCORDING: EN-ISO 9013-5-4-1		MATERIAL: See List	
	MATERIAL CERTIFICATE: 3.1 (OR 2.2 WHEN S235JR)		TREATMENT: None	
	GALVANIZING ACCORDING: EN ISO 1461		STATUS: Released	
	BEND RADIUS UNLESS DEFINED R <sub>t</sub> =1			
TOLERANCES UNLESS OTHERWISE SPECIFIED:				
GENERAL ROUGHNESS Ra x	DIMENSION: ± x	ANGLE: ± x°	MODEL NUMBER TCA0154	REVISION: 0
DESCRIPTION: <b>CT-S-SW-612 Container top with side wall ISO and HC</b>				
SCALE: 1:50	UNITS mm	PROJECTION: 	MODIFIED ON: 26-09-2024 MODIFIED BY: AVA	APPROVED ON: 26-09-2024 APPROVED BY: BVB
		MASS: 4012,6 kg	Sheet 4 of 5	Size: A2
© KROFTMAN STRUCTURES B.V. Duplication and copying without written permission of the owner is prohibited				

DRAWING NAME: TCA0154

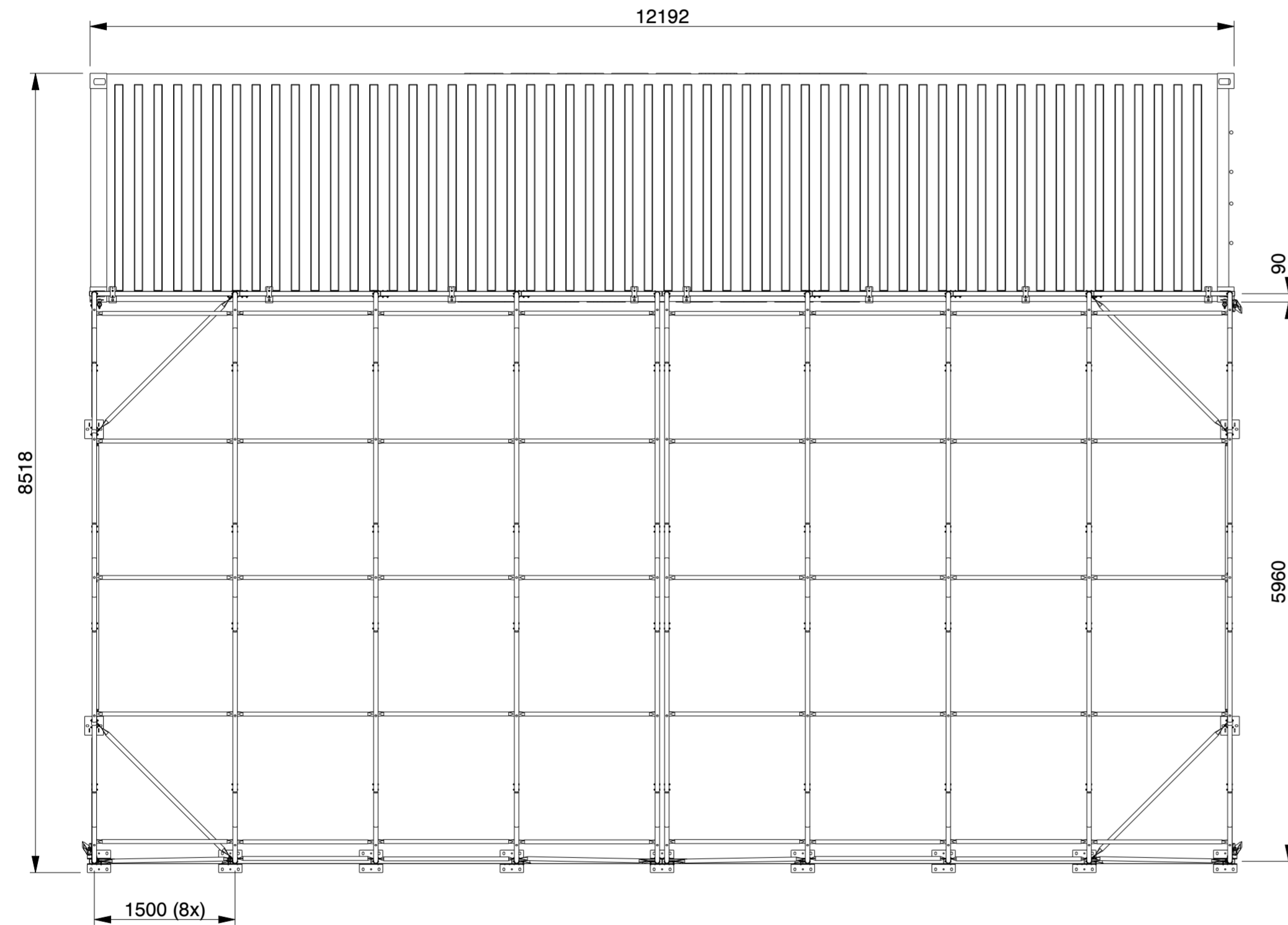

ISO containers  
Optional end walls

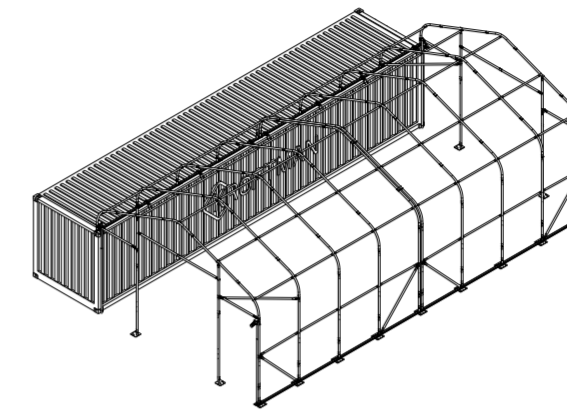

SCALE 1:200

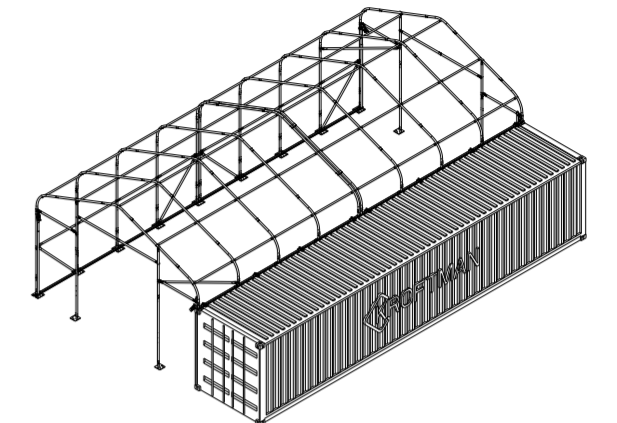

SCALE 1:200

High-Cube containers  
Optional end walls

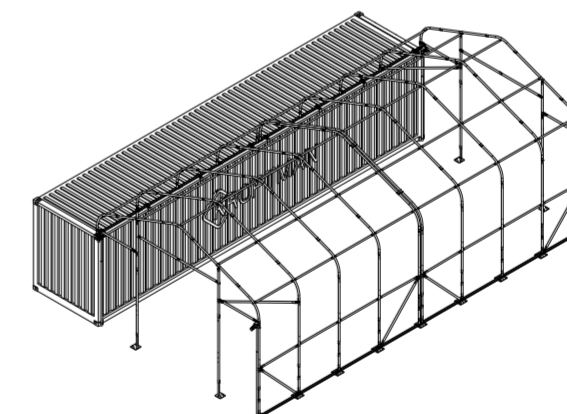

SCALE 1:200

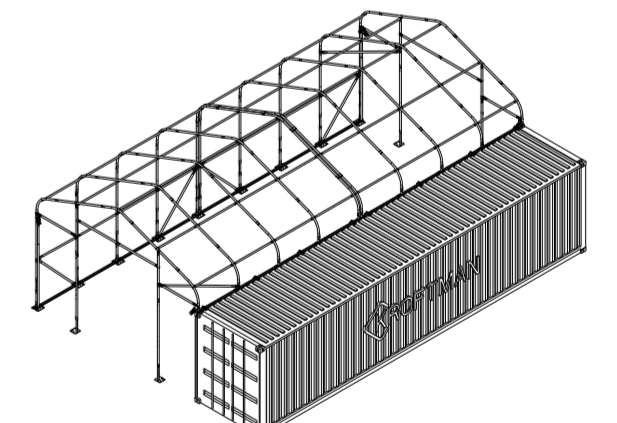

SCALE 1:200

<b>KROFTMAN</b>	LASERCUT ACCORDING: EN-ISO 9013-5-4-1		MATERIAL: See List	
	MATERIAL CERTIFICATE: 3.1 (OR 2.2 WHEN S235JR)		TREATMENT: None	
	GALVANIZING ACCORDING: EN ISO 1461		STATUS: Released	
	BEND RADIUS UNLESS DEFINED R <sub>i</sub> =t			
TOLERANCES UNLESS OTHERWISE SPECIFIED:				
GENERAL ROUGHNESS Ra ✓	DIMENSION: ±x	ANGLE: ±x°	MODEL NUMBER TCA0154	REVISION: 0
DESCRIPTION: CT-S-SW-612 Container top with side wall ISO and HC				
SCALE: 1:50	UNITS: mm	PROJECTION: 	MODIFIED ON: 26-09-2024	APPROVED ON: 26-09-2024
			MODIFIED BY: AVA	APPROVED BY: BVB
			MASS: 4012,6 kg	Sheet 5 of 5 Size: A2
© KROFTMAN STRUCTURES B.V. Duplication and copying without written permission of the owner is prohibited				

DRAWING NAME: TCA0154