

Container shelter/ Containerüberdachung / Abris sur containers



KROFTMAN CT-S-1200

Assembly manual for end wall cover

Montageanleitung für Stirnwandabdeckung

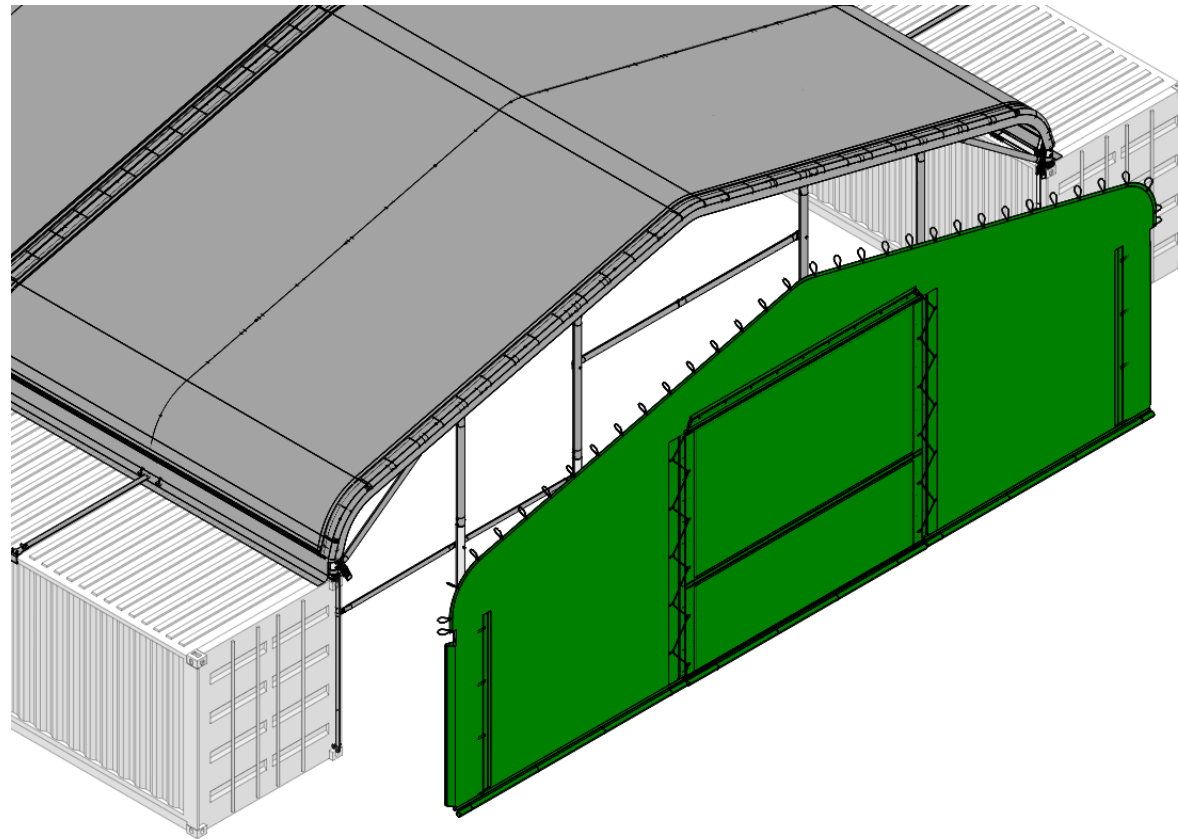
Manuel d'assemblage pour le couvercle de la paroi d'extrémité



 Delivered with end wall frame crate
 Geliefert mit Stirwandrahmenkiste
 Livré avec une caisse à cadre mural d'extrémité



BO-10 40 1x
 2x

BO-9 2x

8x K014
 4x K028A
 4x K028

K044 79x

8x K041

 Delivered in roll-up system package
 Kommt in der Kurbel Verpackung
 Livré dans un ensemble de systèmes à enroulement



1x K045

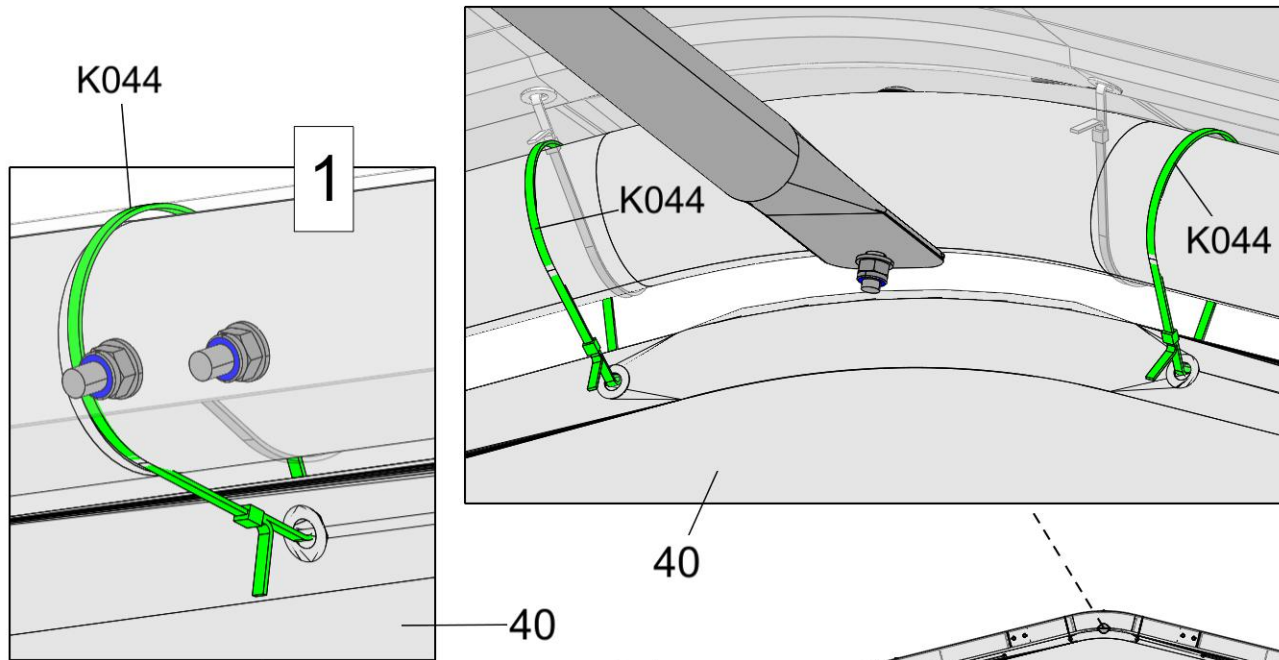

K047 1x

K046 2x

4x DIN7504N
 Ø4.2x13





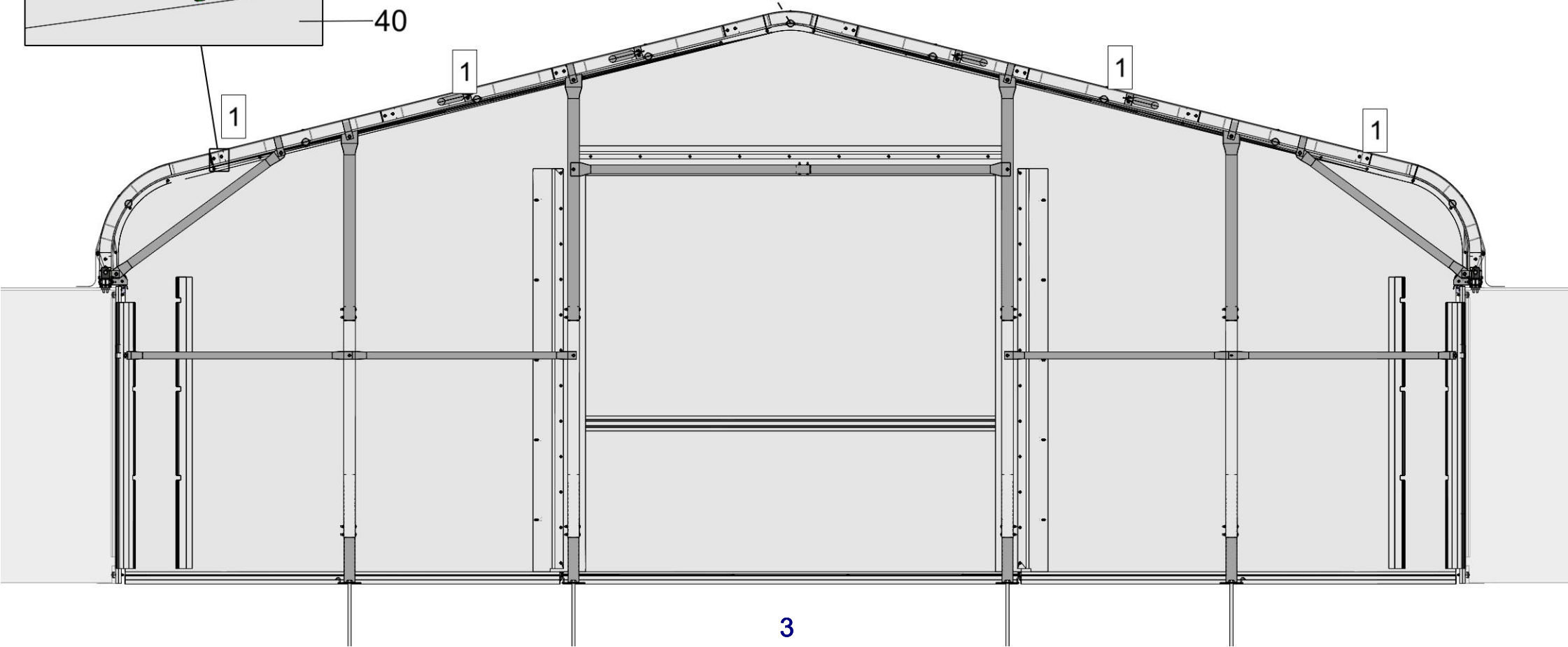

 Secure the cover here with 6 tie wraps
 Sichern Sie die Plane hier mit 6 Kabelbindern
 Fixer la couverture ici avec 6 attaches

 Seen from the inside
 Von innen gesehen
 Vu de l'intérieur

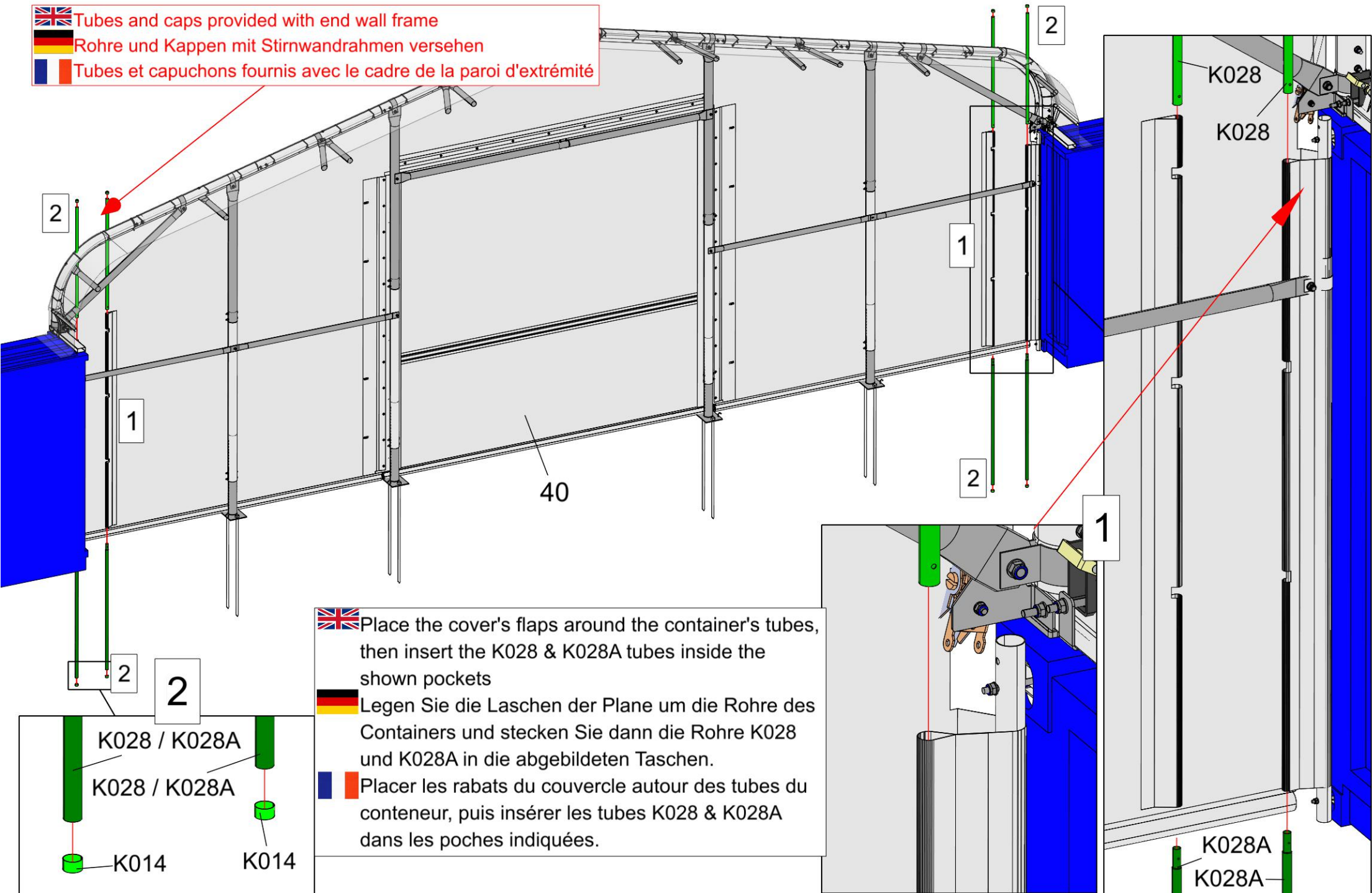



 Tubes and caps provided with end wall frame
 Rohre und Kappen mit Stirwandrahmen versehen
 Tubes et capuchons fournis avec le cadre de la paroi d'extrémité



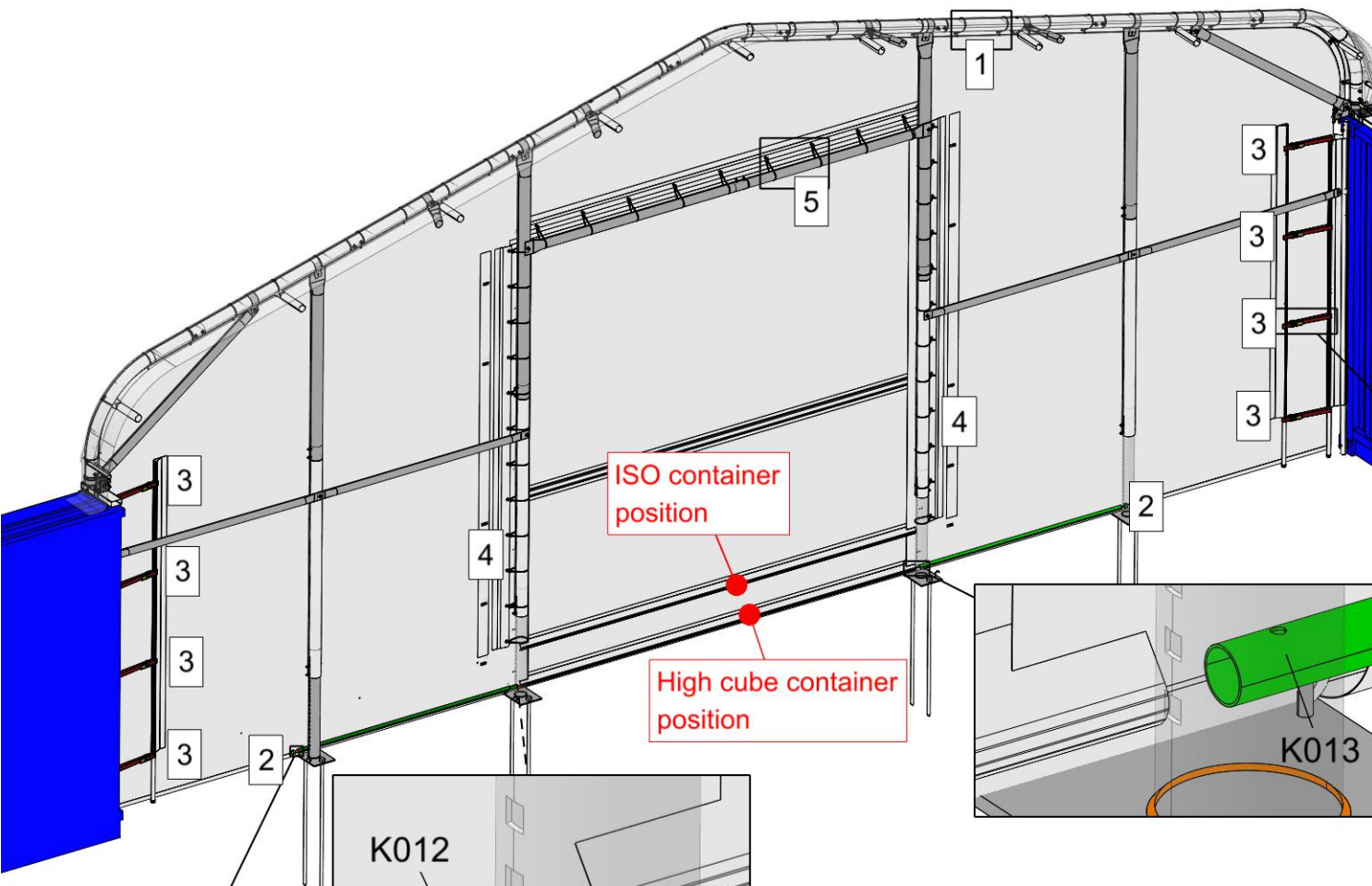



 Place the cover's flaps around the container's tubes, then insert the K028 & K028A tubes inside the shown pockets
 Legen Sie die Laschen der Plane um die Rohre des Containers und stecken Sie dann die Rohre K028 und K028A in die abgebildeten Taschen.
 Placer les rabats du couvercle autour des tubes du conteneur, puis insérer les tubes K028 & K028A dans les poches indiquées.

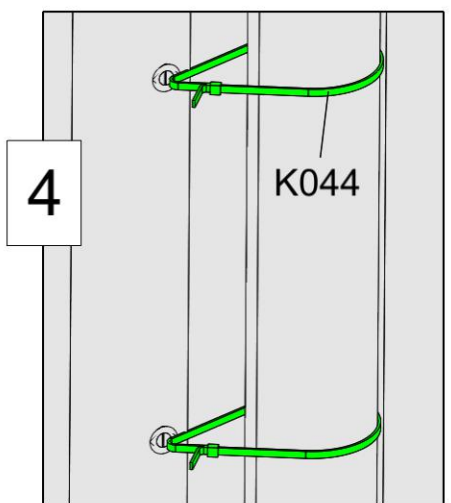
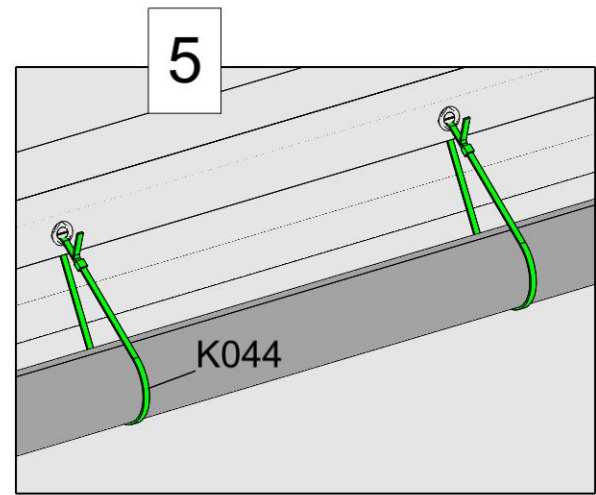
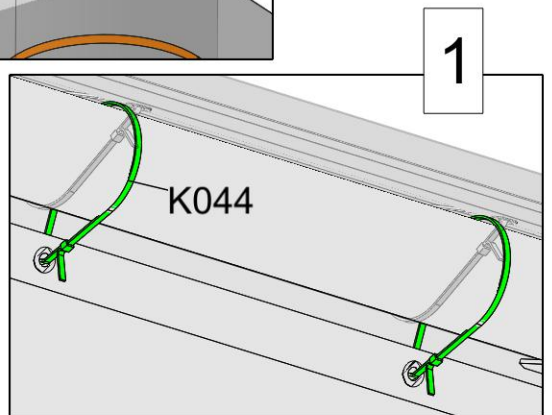
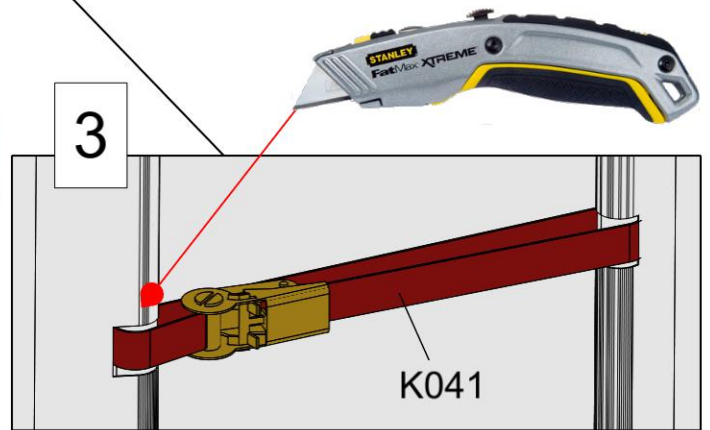
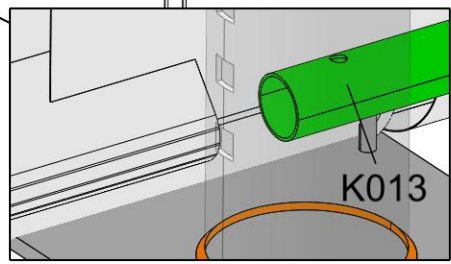
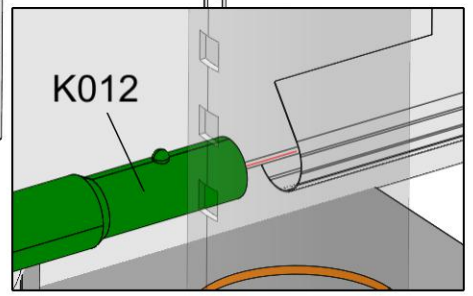
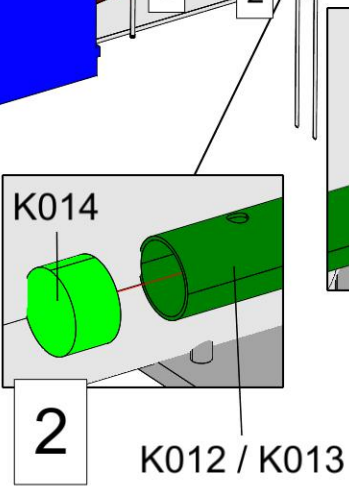

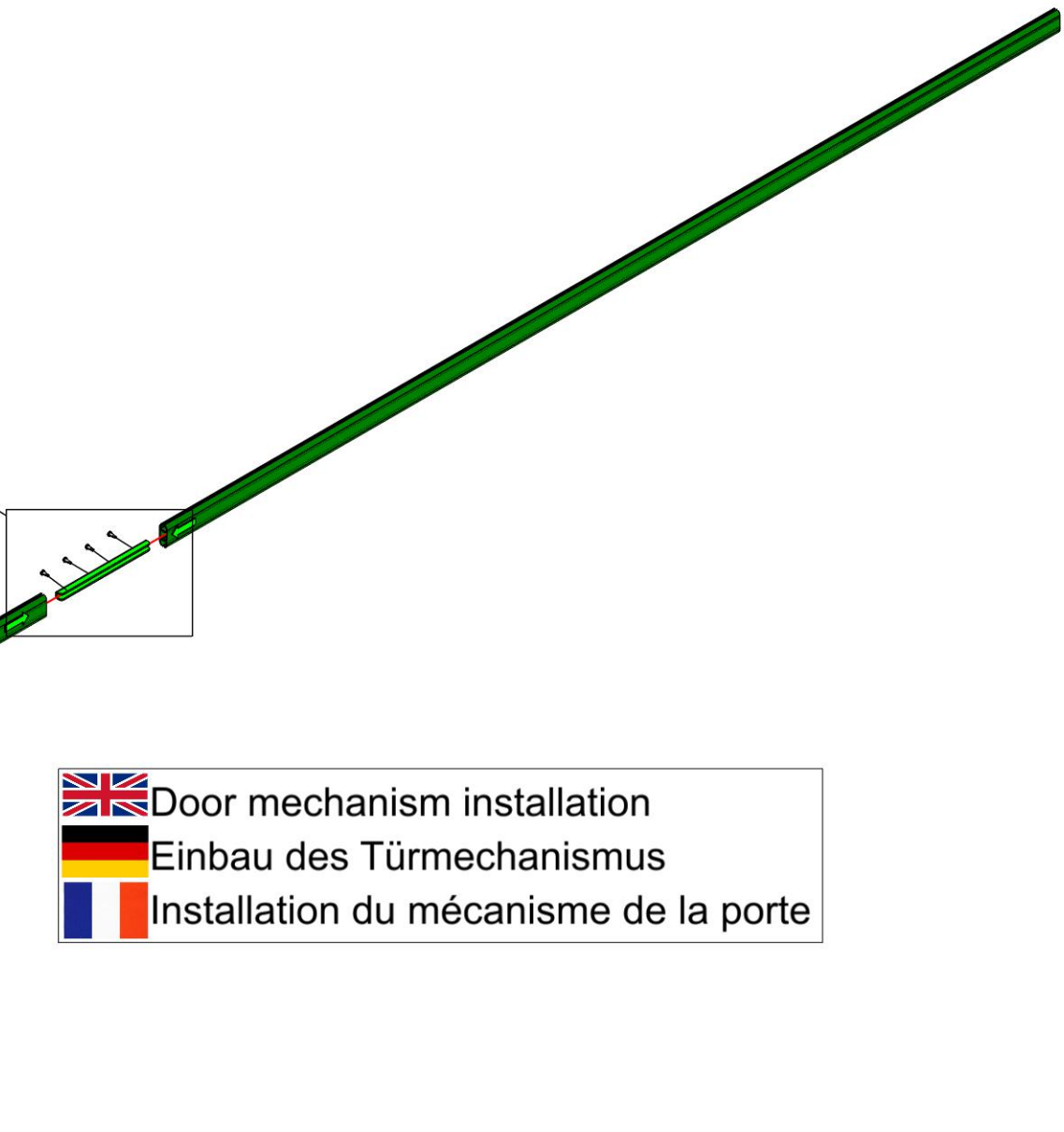
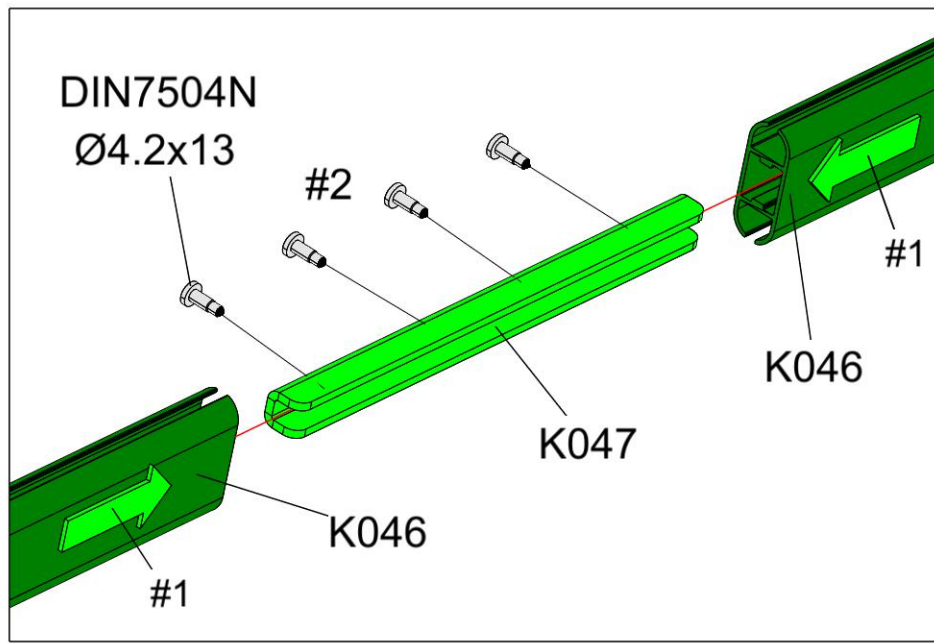



 Install all tie wraps and ratchet straps as tight as possible
 Bringen Sie alle Spanngurte und Ratschenbänder so fest wie möglich an.
 Installer toutes les sangles d'arrimage et les sangles à cliquet aussi serrées que possible.



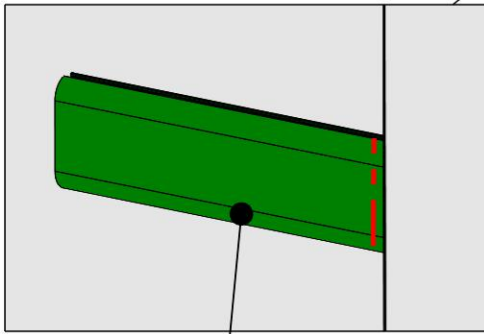
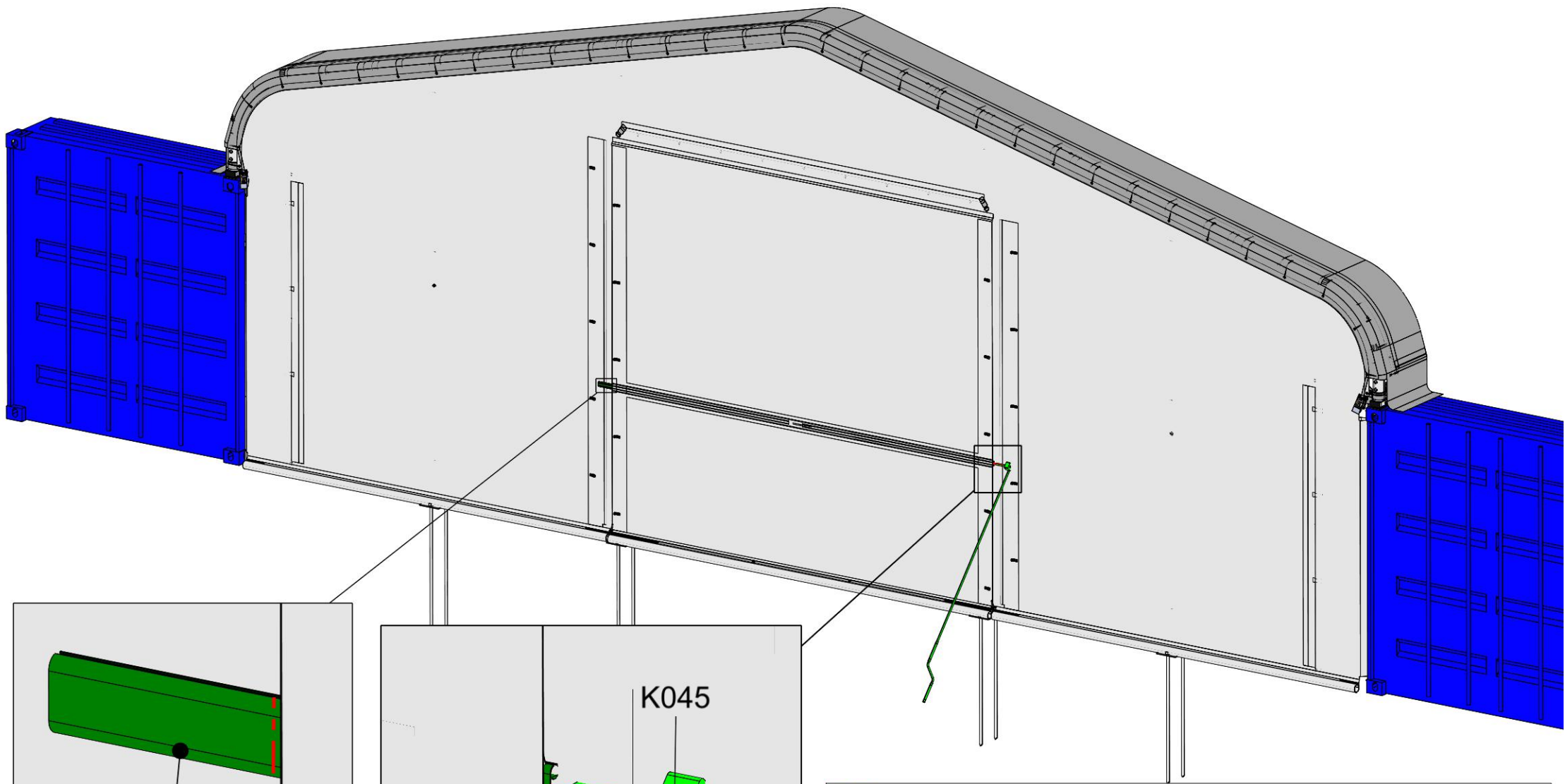





-  Door mechanism installation
-  Einbau des Türmechanismus
-  Installation du mécanisme de la porte

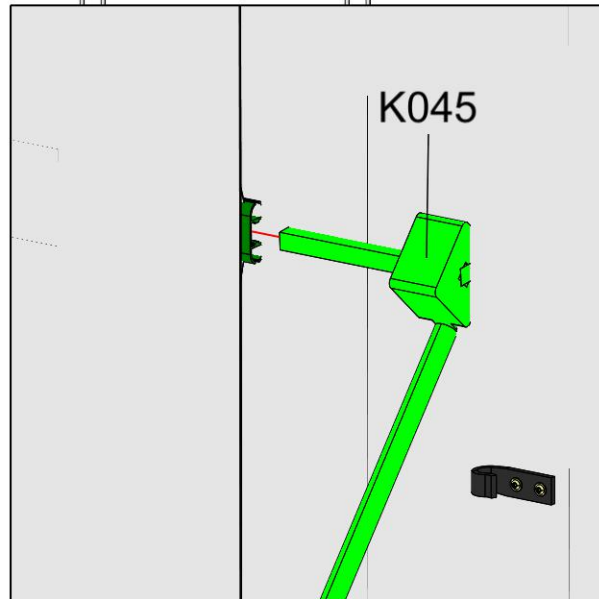

 Cut to size of the door
 Zuschnitt auf die Größe der Tor
 Couper à la taille de la porte





 Insert the door mechanism through its special pocket in the door and attach the handle.
 Führen Sie den Türmechanismus in die dafür vorgesehene Tasche in der Tür ein und befestigen Sie den Griff.
 Insérez le mécanisme de la porte dans la poche prévue à cet effet dans la porte et fixez la poignée.

 Use the attached nylon ropes to tie the door cover to the base plate hooks

 Befestigen Sie die Tor mit den beiliegenden Nylonseilen an den Haken der Grundplatte.

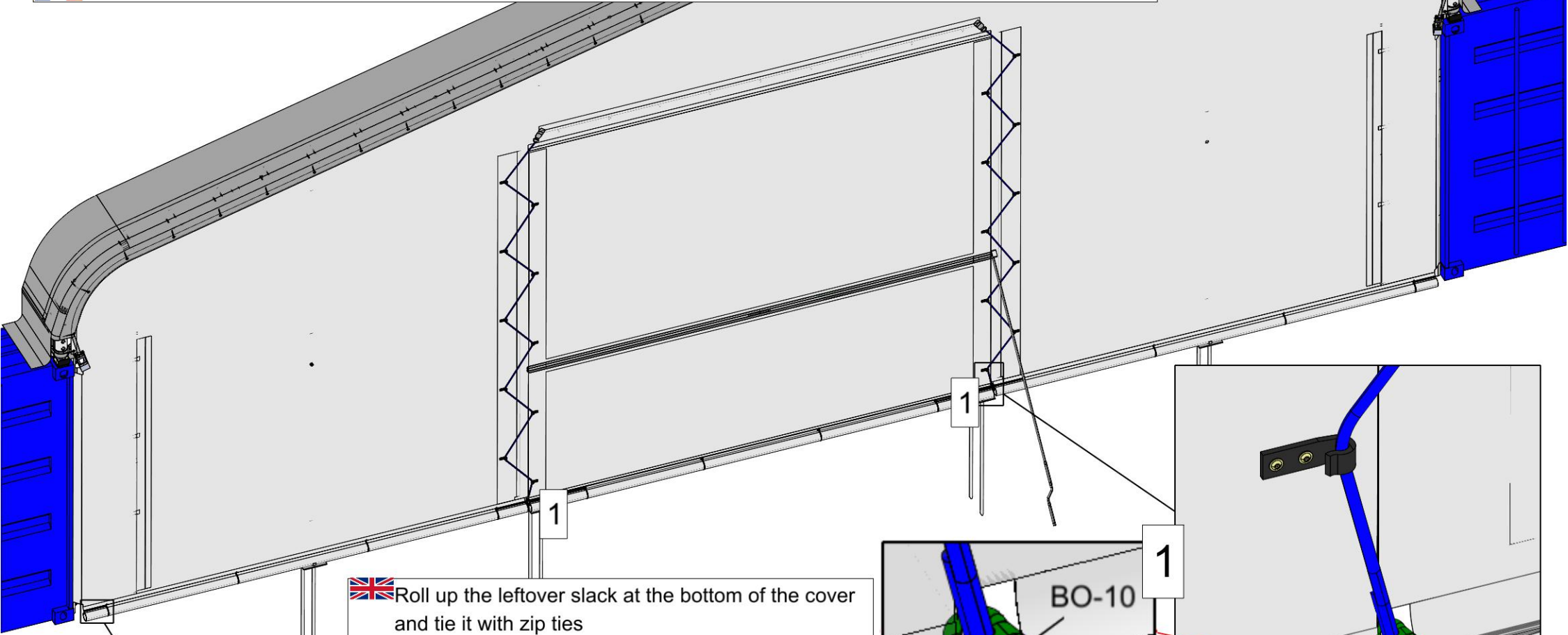
 Utilisez les cordes en nylon jointes pour attacher le couvercle de la porte aux crochets de la plaque de base.



 Roll up the leftover slack at the bottom of the cover and tie it with zip ties

 Rollen Sie den Rest der Plane unten auf und binden Sie ihn mit Kabelbindern zusammen.

 Enrouler le mou restant au bas de la couverture et l'attacher à l'aide de colliers de serrage.

