

Container shelter/ Containerüberdachung / Abris sur containers



KROFTMAN CT-A-800

Assembly manual for end wall cover

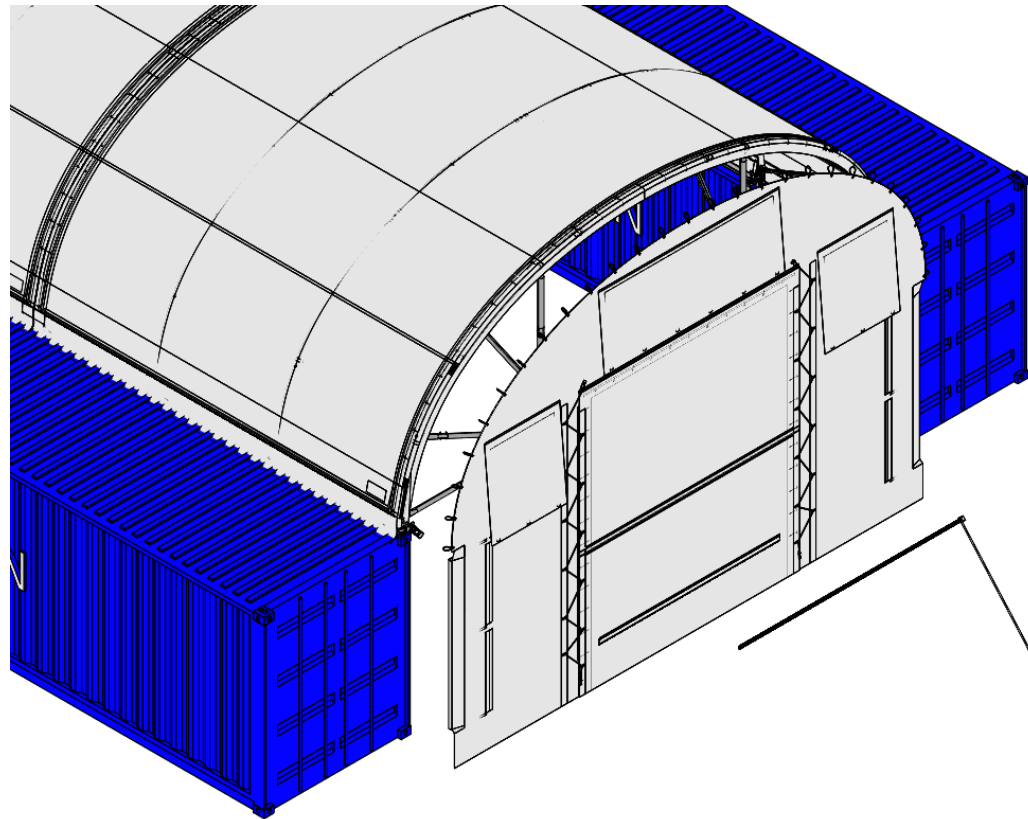

Montageanleitung für Stirnwandabdeckung

Manuel d'assemblage pour le couvercle de la paroi d'extrémité



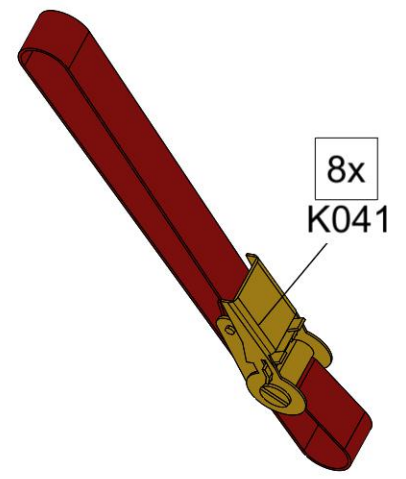
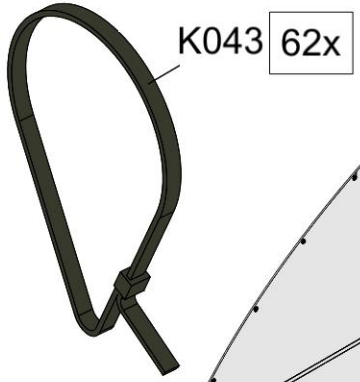
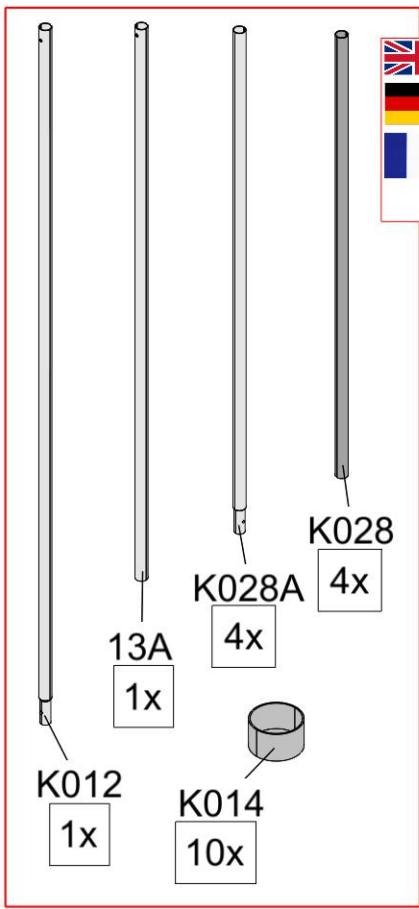



 Delivered with end wall frame crate
 Geliefert mit Stirnwandrahmenkiste
 Livré avec une caisse à cadre mural d'extrémité

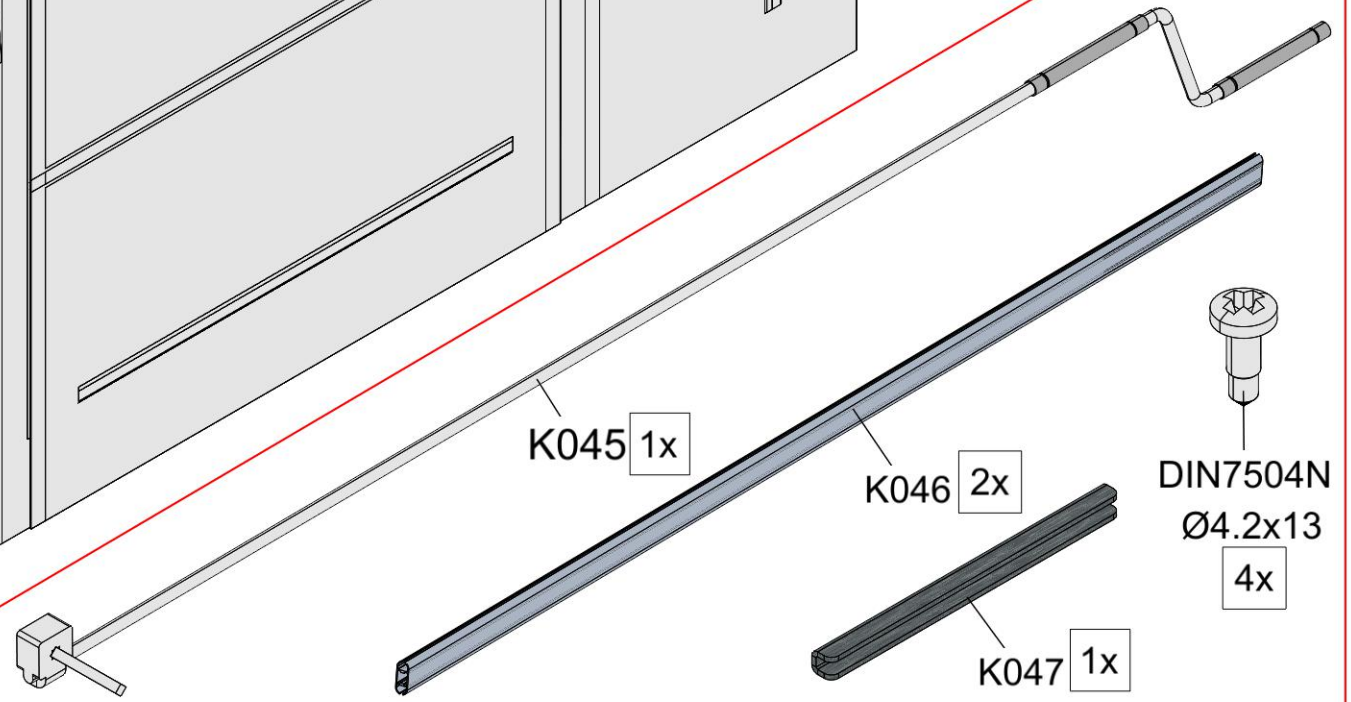
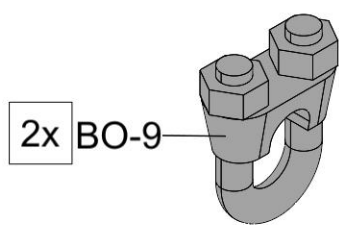
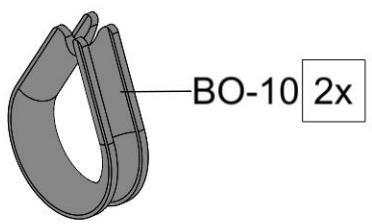
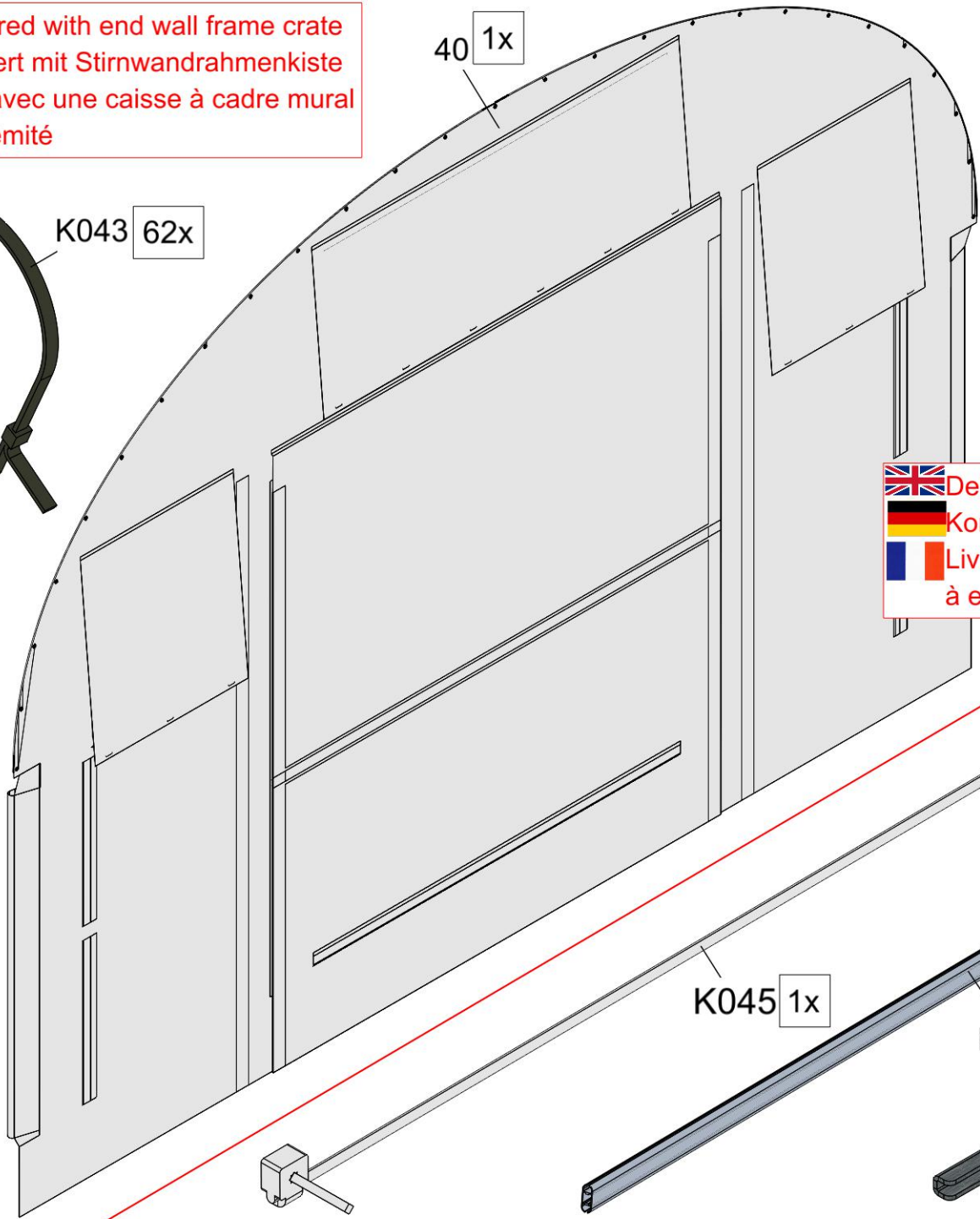

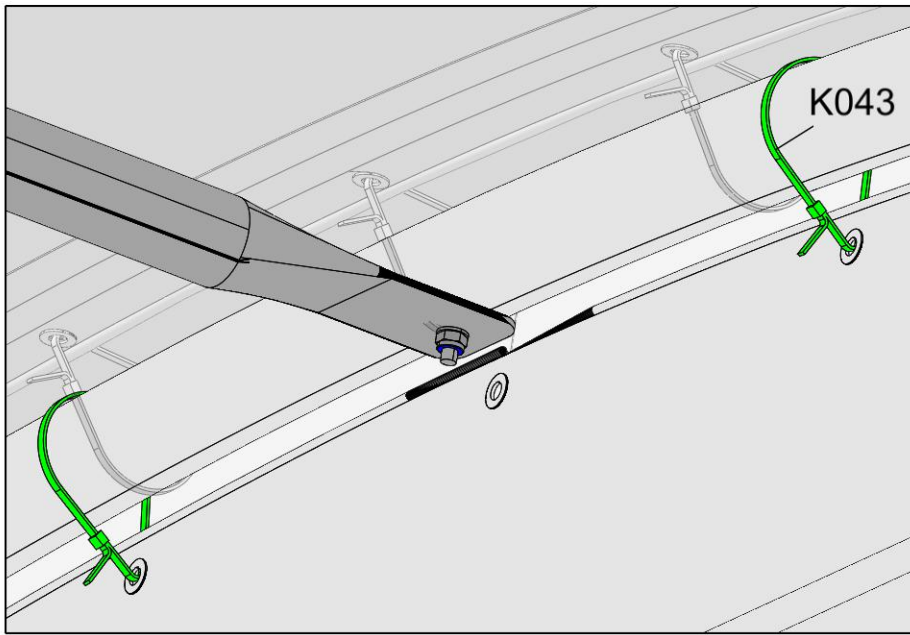

 Delivered in roll-up system package
 Kommt in der Kurbel Verpackung
 Livré dans un ensemble de systèmes à enroulement







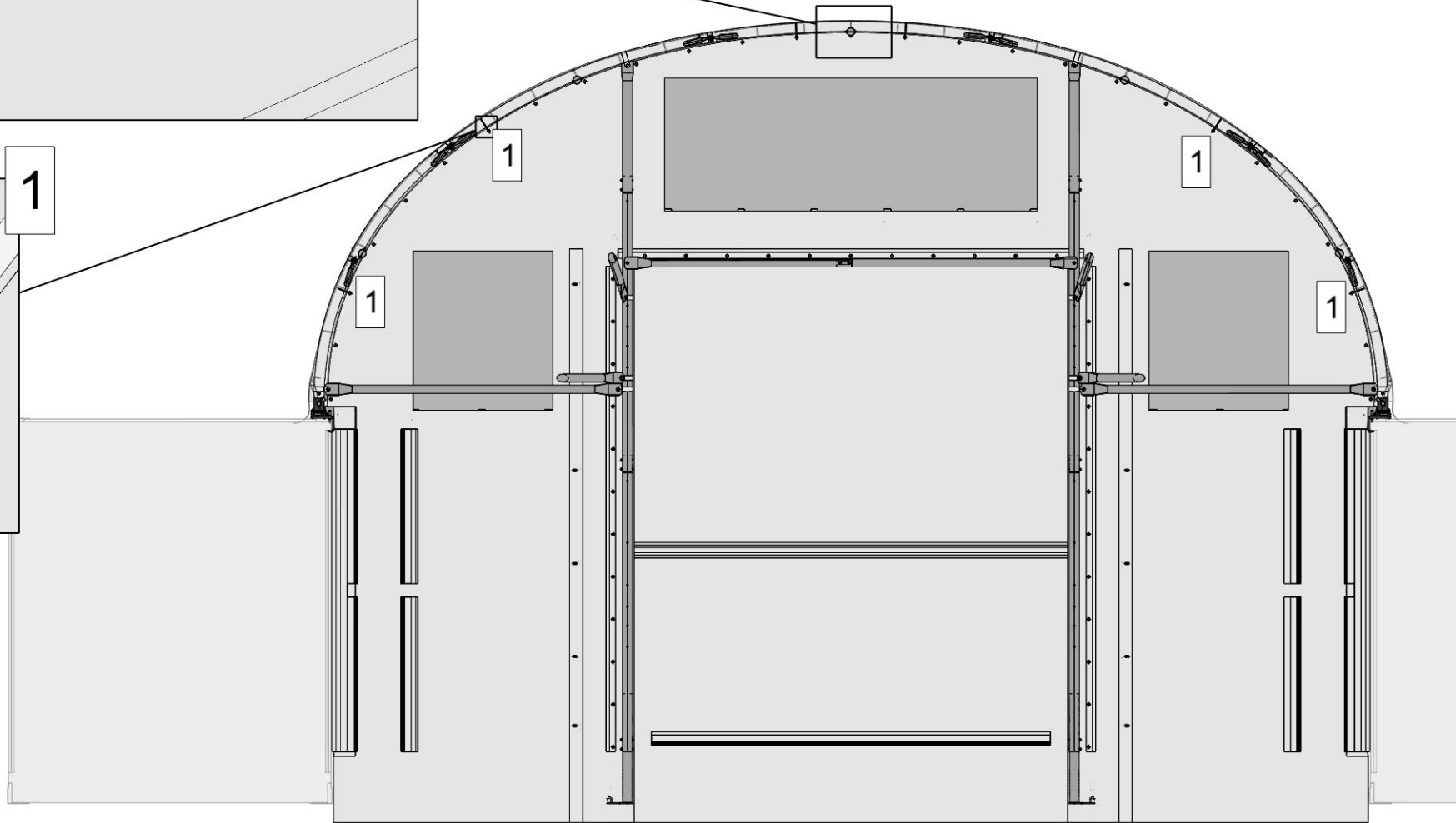
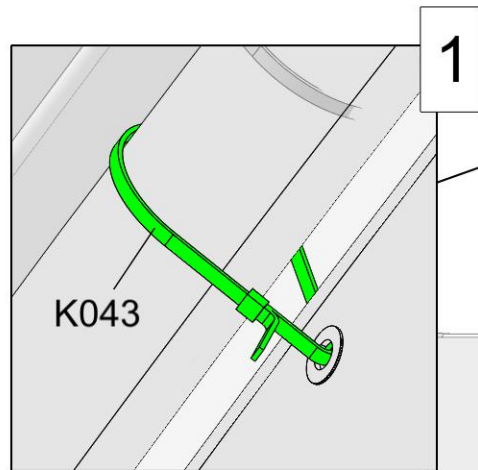

 Secure the cover here with 6 tie wraps
 Sichern Sie die Plane hier mit 6 Kabelbindern
 Fixer la couverture ici avec 6 attaches

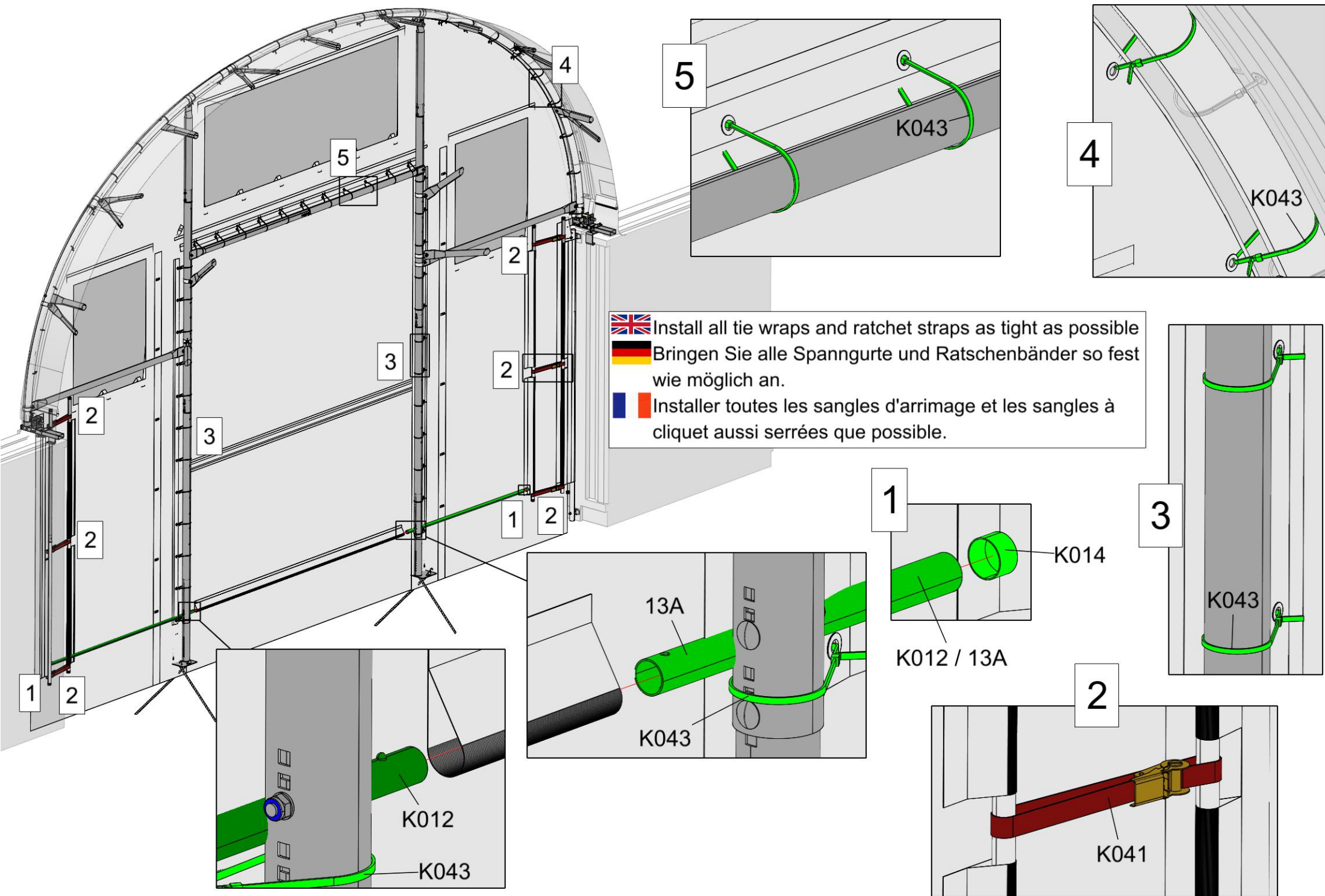

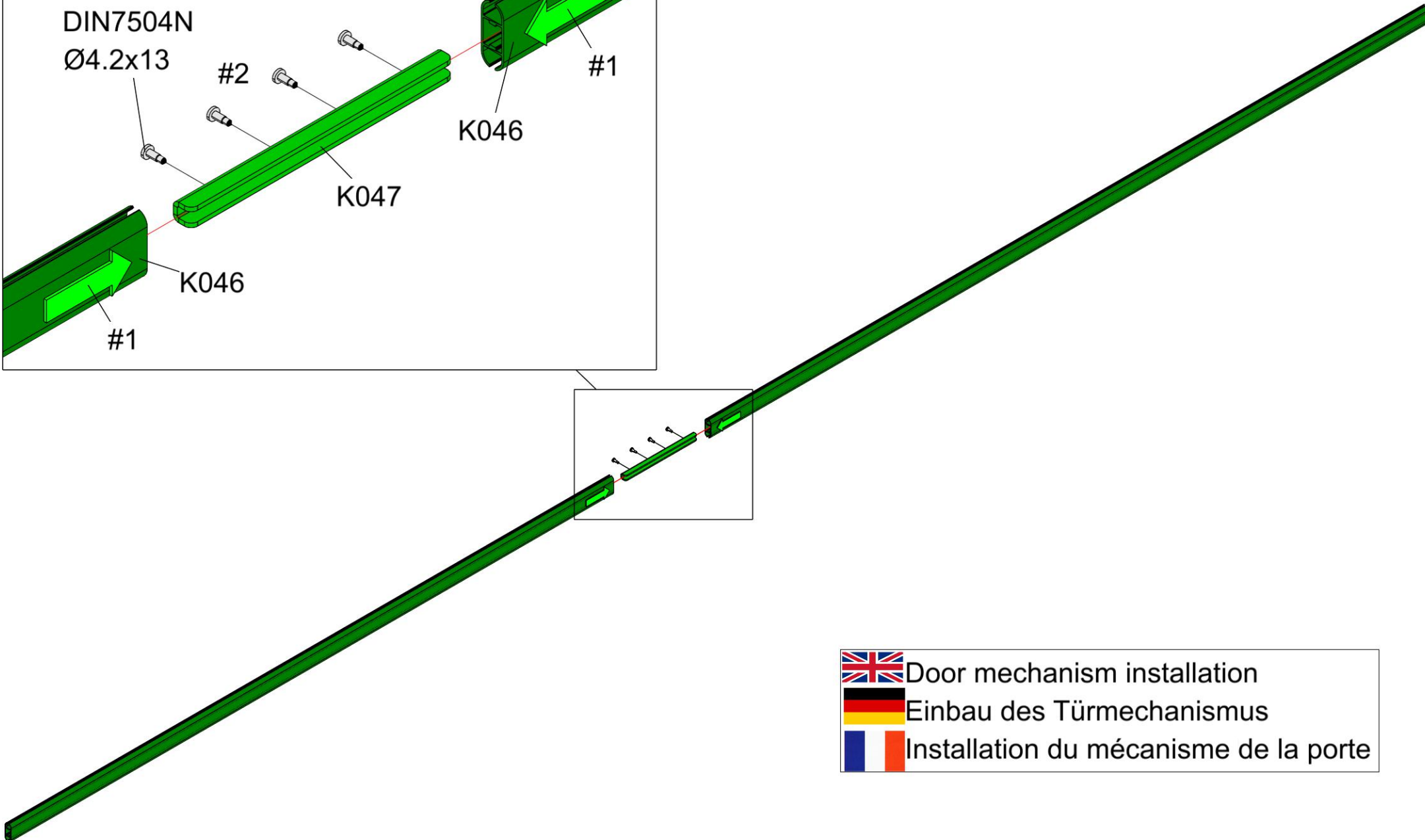
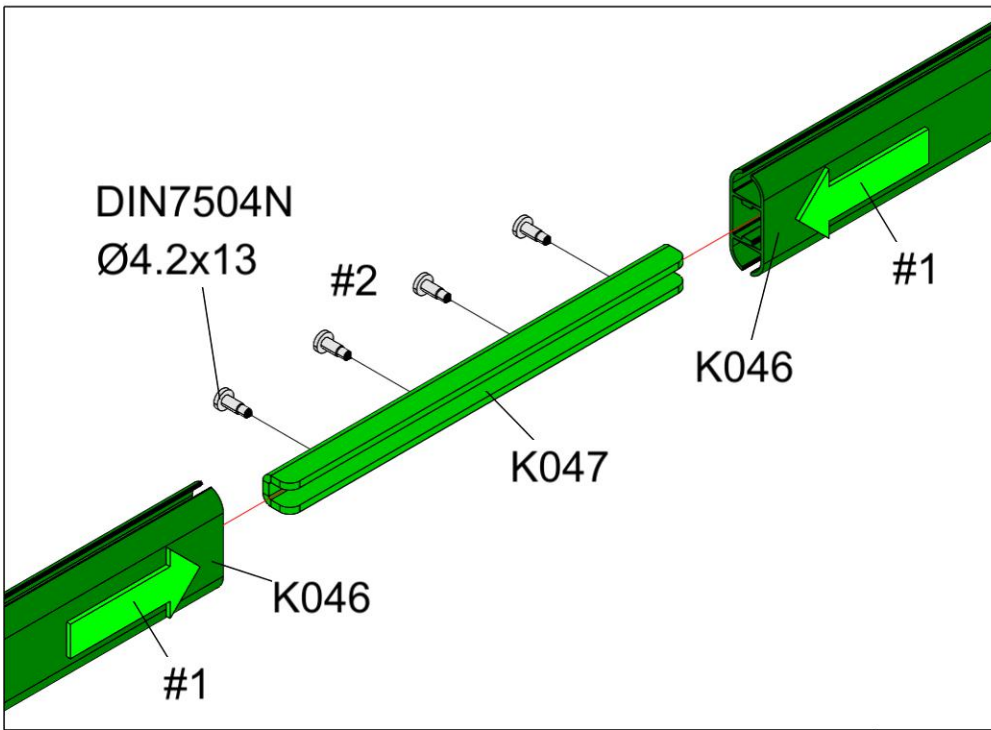
 Seen from the inside
 Von innen gesehen
 Vu de l'intérieur









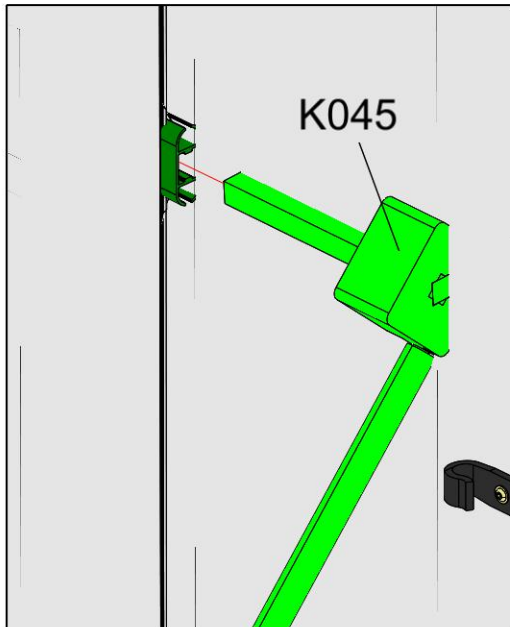
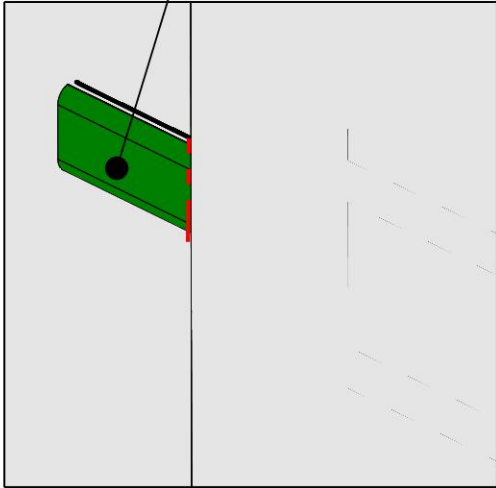

-  Door mechanism installation
-  Einbau des Türmechanismus
-  Installation du mécanisme de la porte



 Cut to size of the door
 Zuschnitt auf die Größe
der Tor
 Couper à la taille de la
porte

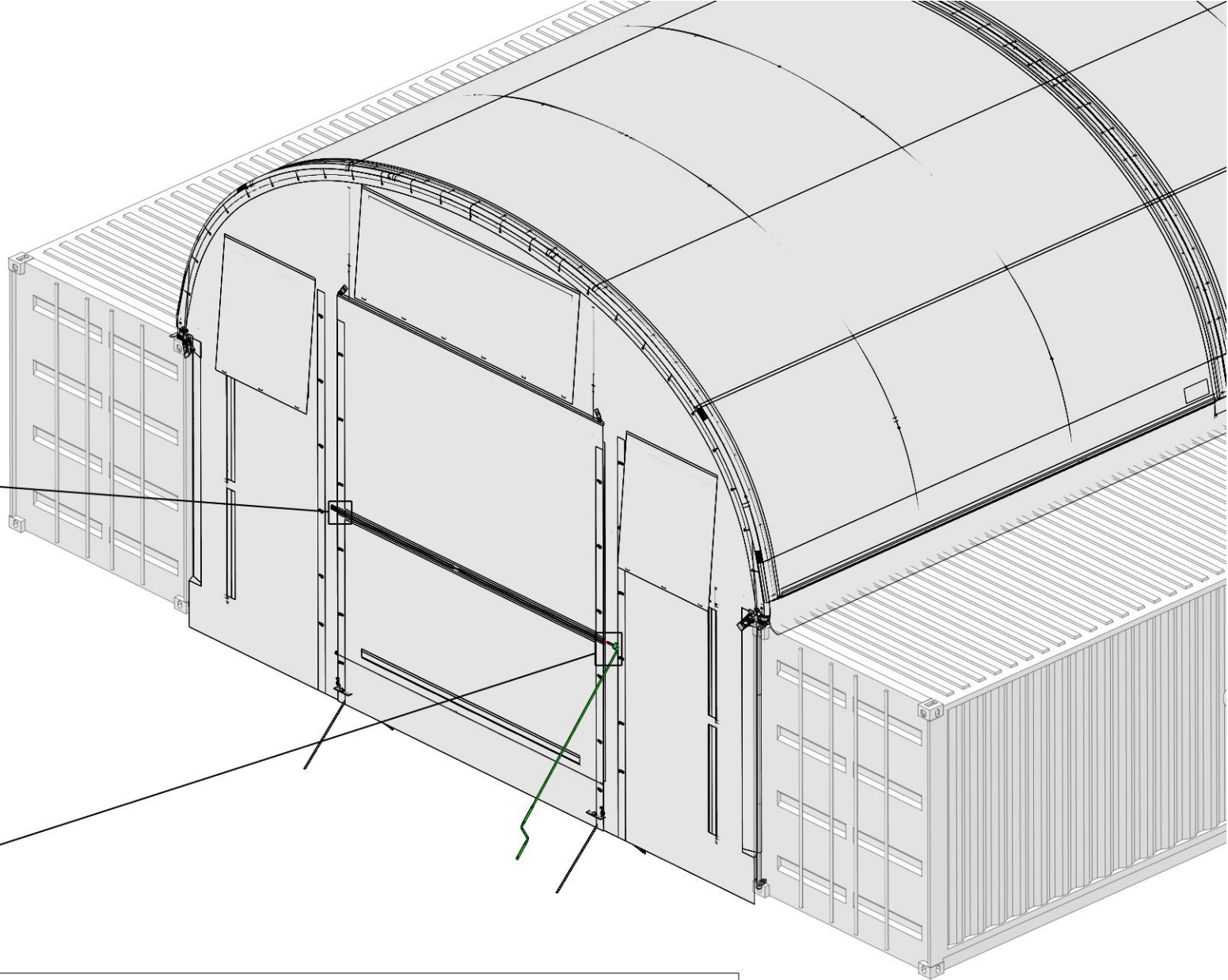

 Insert the door mechanism through its special pocket in the door
and attach the handle.
 Führen Sie den Türmechanismus in die dafür vorgesehene Tasche
in der Tür ein und befestigen Sie den Griff.
 Insérez le mécanisme de la porte dans la poche prévue à cet effet
dans la porte et fixez la poignée.

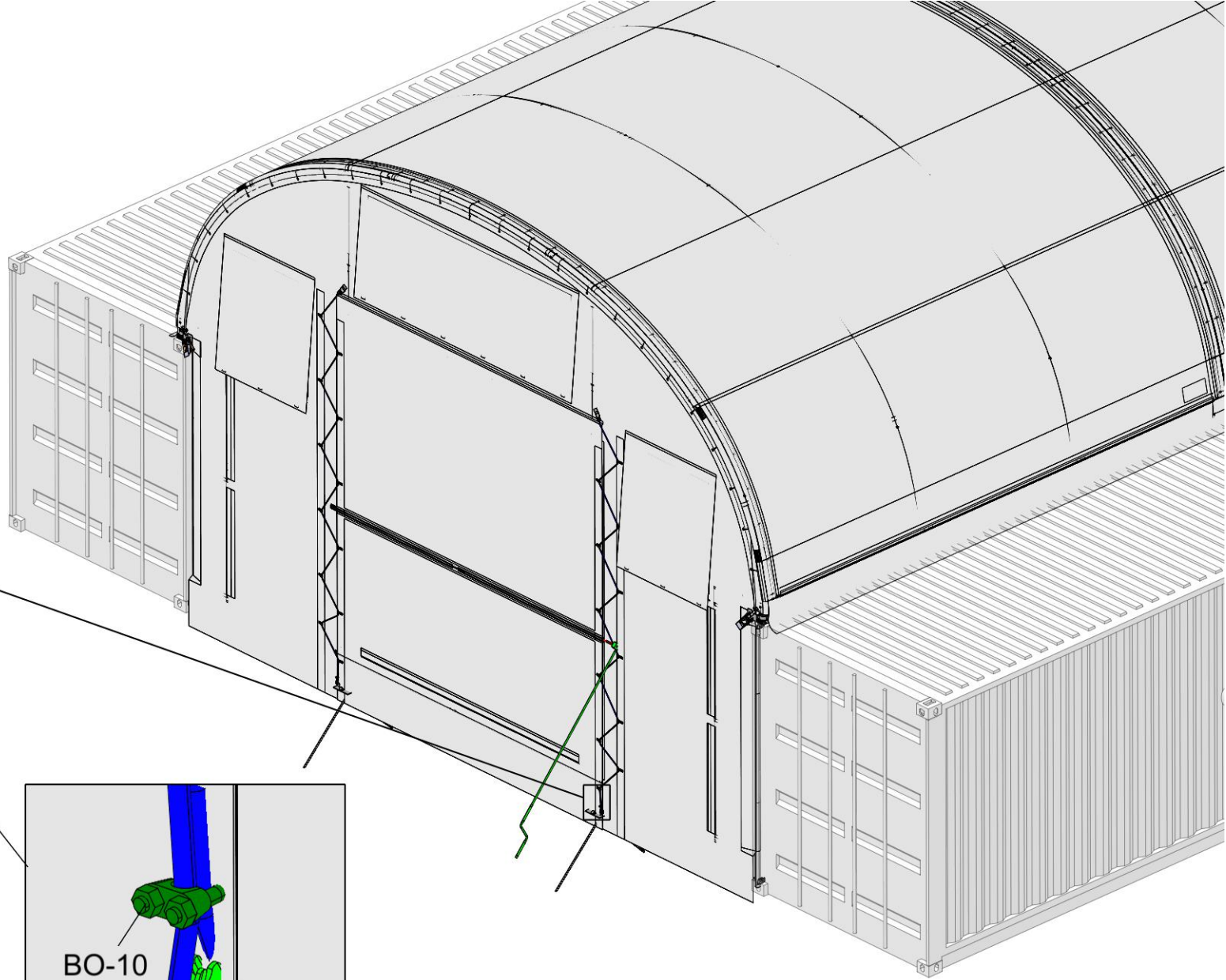
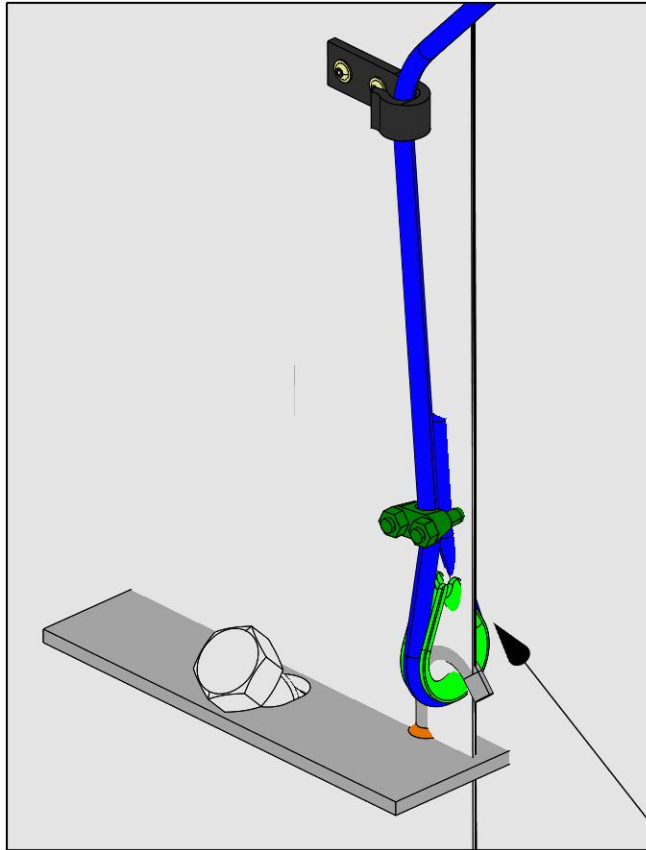



-  Use the attached nylon ropes to tie the door cover to the base plate hooks
-  Befestigen Sie die Tor mit den beiliegenden Nylonseilen an den Haken der Grundplatte.
-  Utilisez les cordes en nylon jointes pour attacher le couvercle de la porte aux crochets de la plaque de base.

