

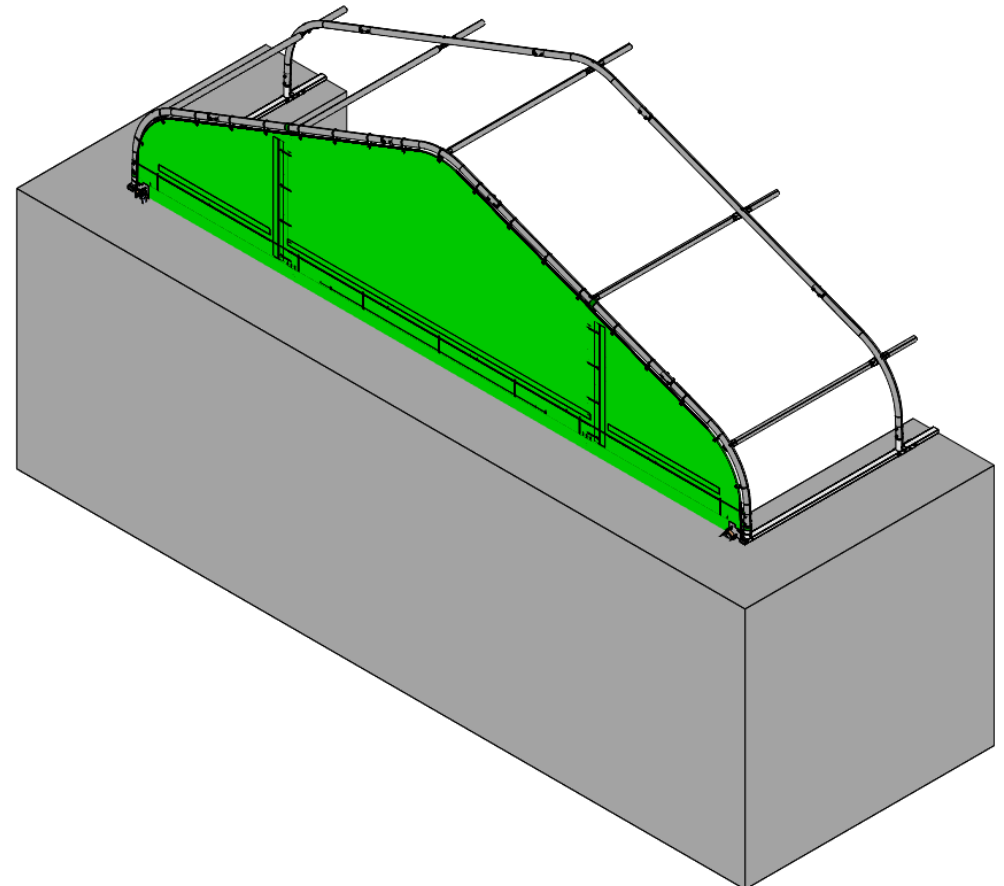

KROFTMAN CT-S-HS-600 / CT-S-H-600

Assembly manual for suspended and unsuspended half end wall cover
Montageanleitung für aufgehängte und nicht aufgehängte halbe Stirnwandplane
Manuel d'assemblage pour le demi-couvercle mural suspendu et non suspend

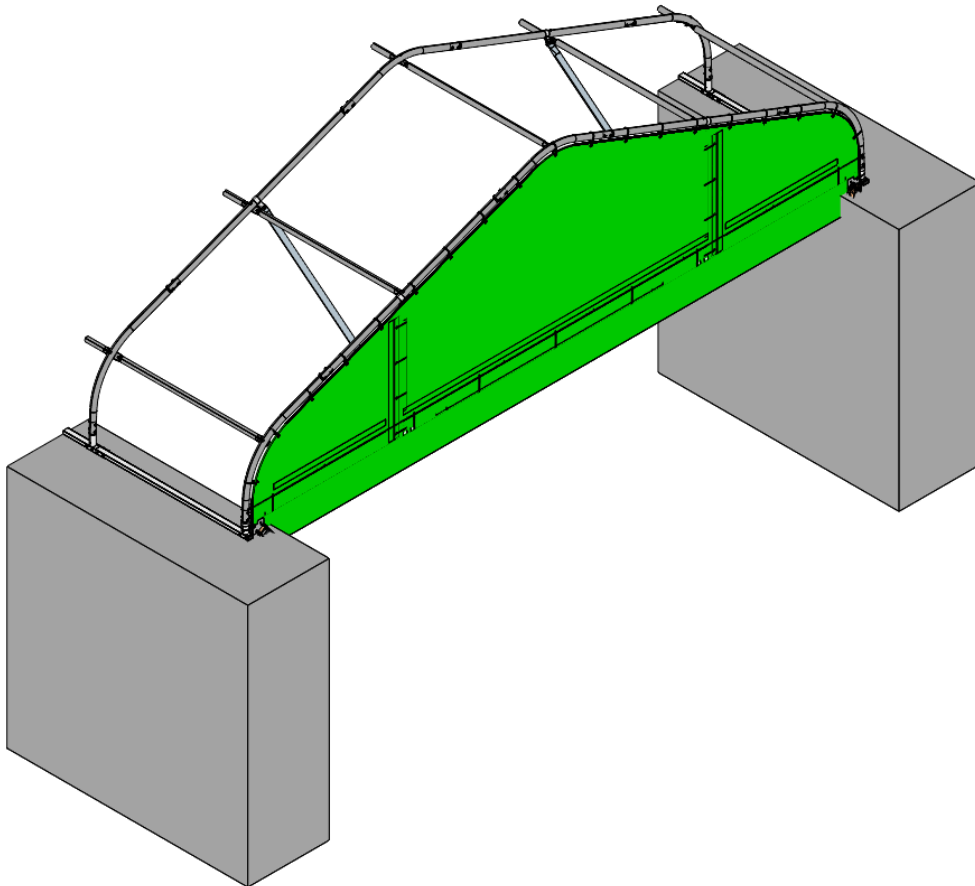

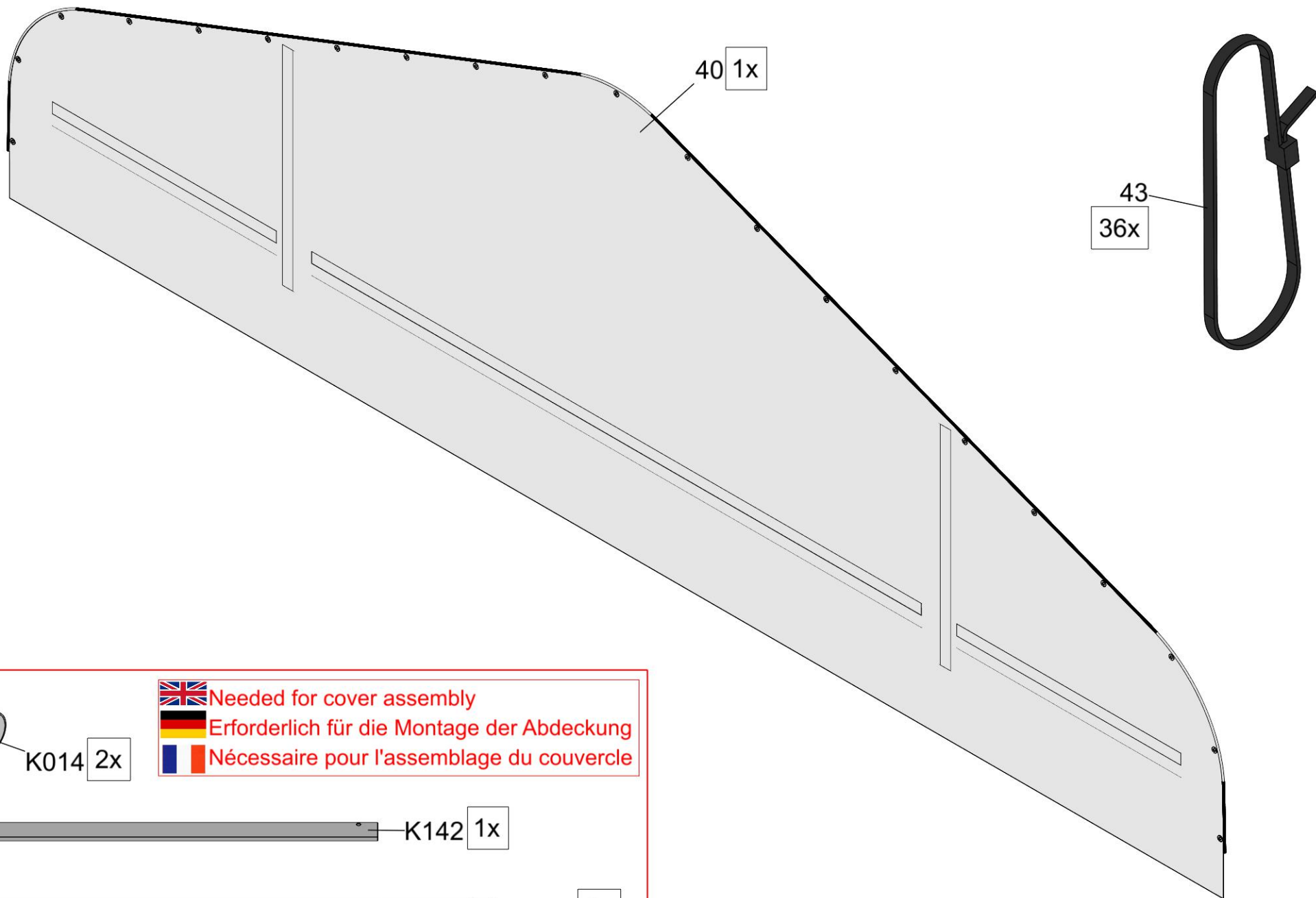



 K014 2x

 Needed for cover assembly

 Erforderlich für die Montage der Abdeckung



 Nécessaire pour l'assemblage du couvercle

 K142 1x

 K143 6x

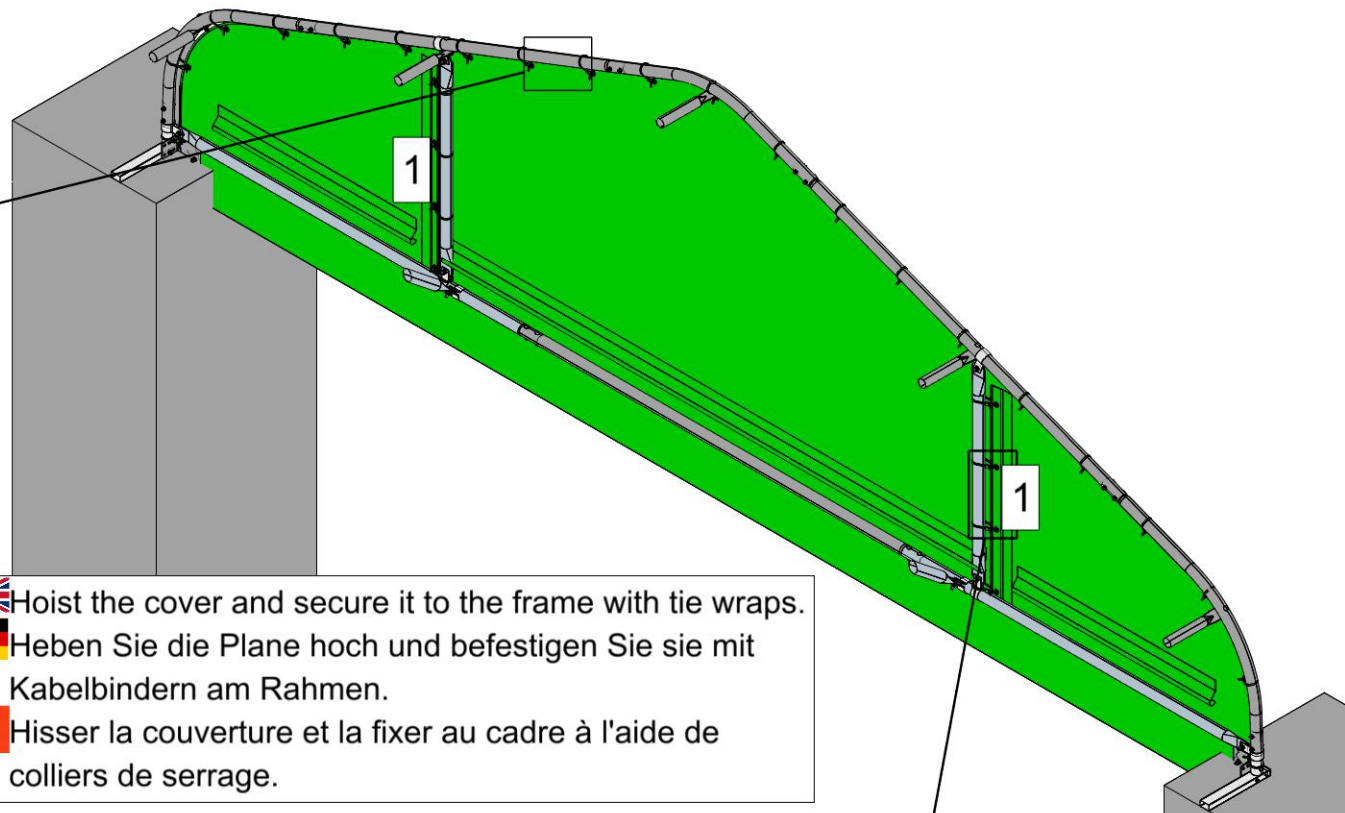
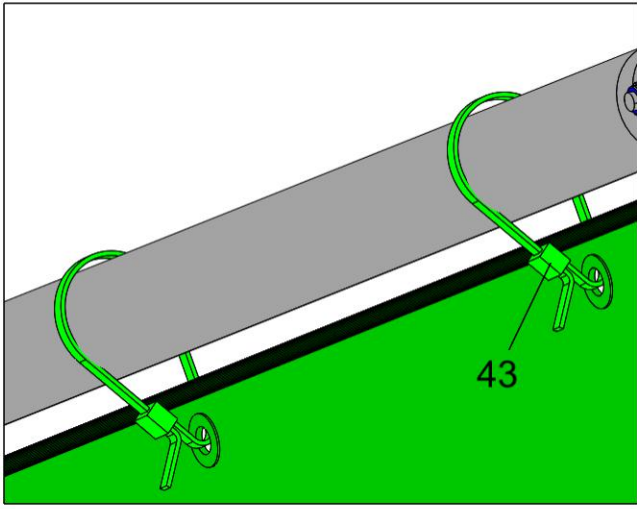
This section contains a list of parts for the cover assembly. It includes a cap (K014, 2x), a rod (K142, 1x), and another rod (K143, 6x). The text is provided in three languages: English, German, and French, each accompanied by a small flag icon.



 Hoist the cover and secure it to the frame with tie wraps.
 Heben Sie die Plane hoch und befestigen Sie sie mit Kabelbindern am Rahmen.
 Hisser la couverture et la fixer au cadre à l'aide de colliers de serrage.

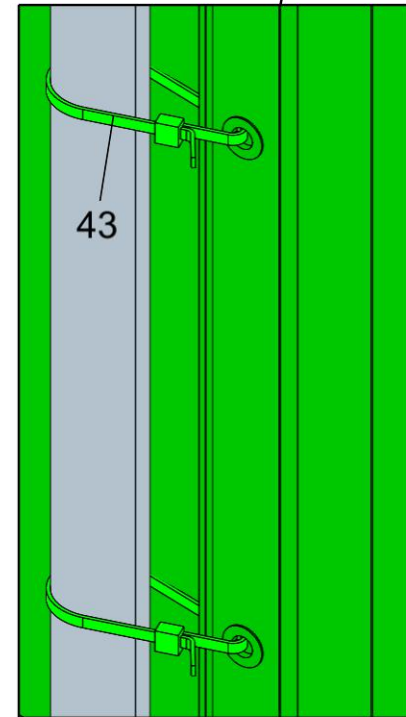
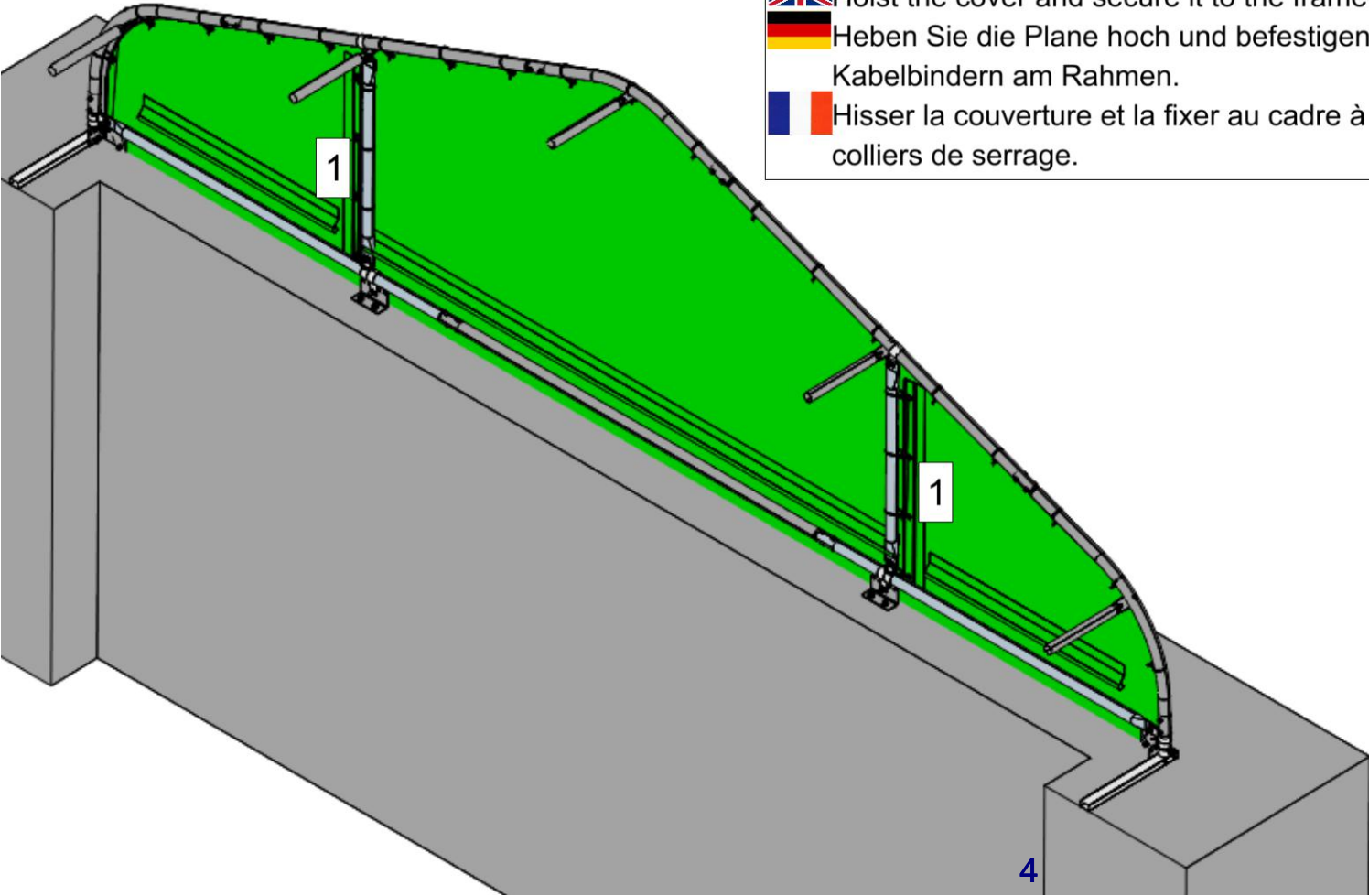





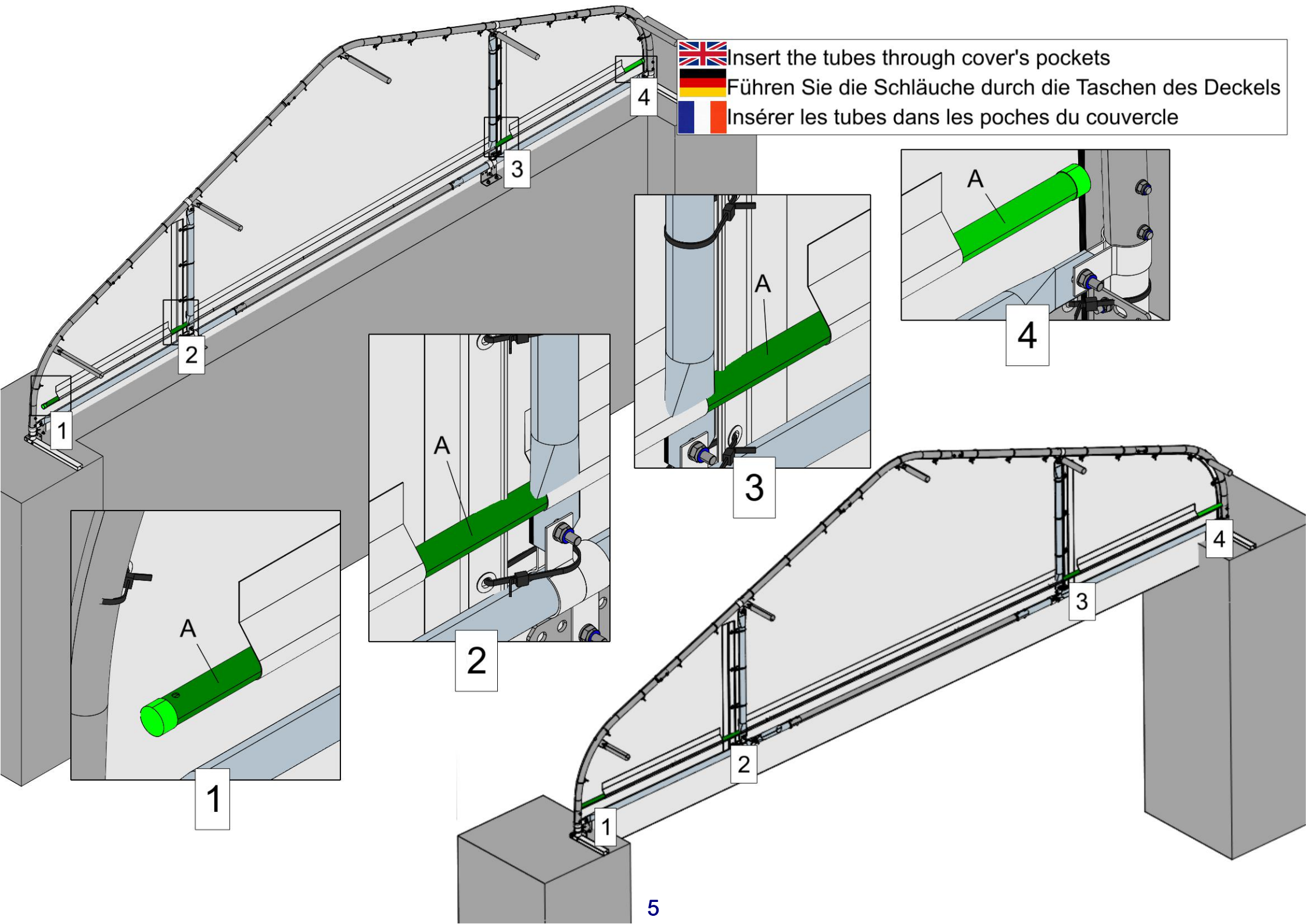

Insert the tubes through cover's pockets

Führen Sie die Schläuche durch die Taschen des Deckels

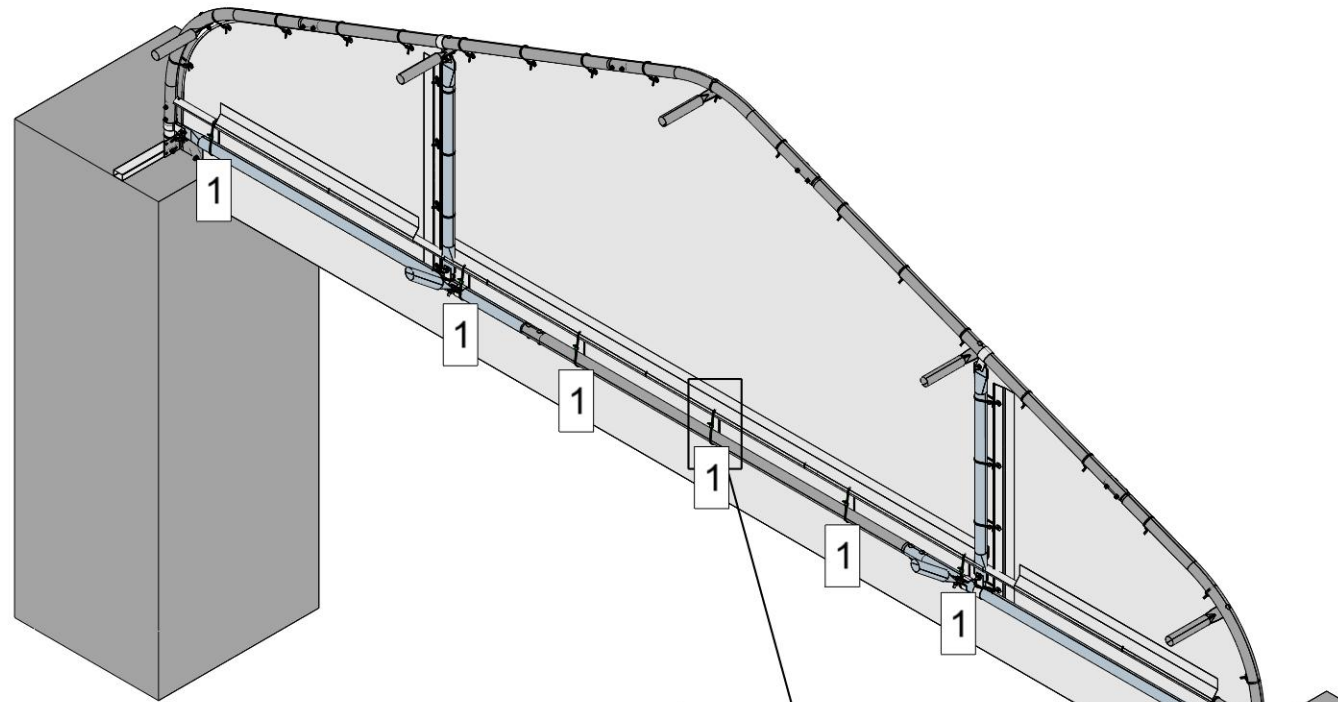
Insérer les tubes dans les poches du couvercle





 Cut the cover for the tie wraps
 Schneiden Sie die Plane für die Kabelbinder zu
 Couper le couvercle pour les attaches

